

YAESU

The radio

FT-891

Advance Manual

HF/50 MHz TRANSCEIVER

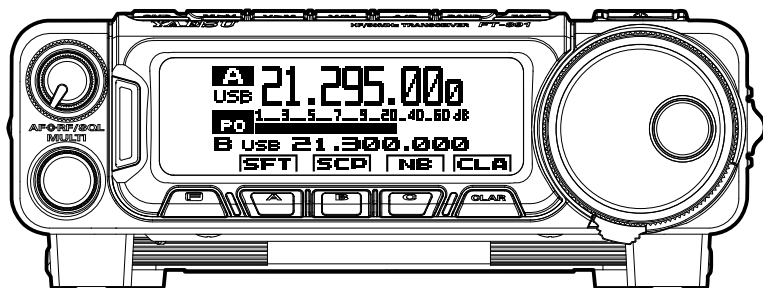

Contents

CW Mode Operation	3	Split Operation Using the TX Clarifier	48
Setup for Straight Key		Split-Frequency Operation	49
(and Straight Key Emulation) Operation	3	Quick Split Operation	50
Using the Built-in Electronic Keyer	4	Memory Operation	51
Adjusting the keyer speed	5	Checking a Memory Channel Status	51
Full Break-in (QSK) Operation	5	Memory Tune (MT) operation	51
Setting the Keyer Weight (Dot/Dash) Ratio	6	Labeling Memories	52
Reversing the Keyer Polarity	6	Displaying the memory tag	52
Selecting the Keyer Operating Mode	7	Memory Groups	53
CW Delay Time Setting	8	Memory Group Assignment	53
CW Pitch Adjustment	8	Choosing the Desired Memory Group	54
CW Spotting (Zero-Beating)	9	Operation on Alaska Emergency Frequency:	
Using the Auto Zeroing System	9	5167.5 kHz (U.S. Version Only)	55
Using the SPOT System	9	Scanning Operation	56
Audio Peak Filter	10	Scan Resume Options	56
Contest Memory Keyer	11	PMS (Programmable Memory Scanning)	57
Message Memory	11	Miscellaneous Setting	58
Text Memory	17	Beep Level	58
Contest Number Programming	23	TOT (Time-Out Timer)	58
Decrementing the Contest Number	23	APO (Automatic Power Off)	59
Transmitting in the Beacon Mode	24	FAN Control	59
FM Mode Operation	25	Meter Peak Hold	60
Basic Operation	25	POP-UP Menu	60
Repeater Operation	26	Key Lamp Dimmer	61
Tone Squelch Operation	27	TX/BUSY Indicator Dimmer	61
DCS Operation	28	RTTY (Radio Teletype) Operation	62
Interference Rejection	29	Example of Connecting RTTY	
CONTOUR Control Operation	29	Communications device	62
WIDTH (IF DSP Bandwidth) Tuning		Connecting to the TU (Terminal Unit)	62
(SSB/CW/RTTY/DATA Modes)	30	Connecting to your Computer	63
Using IF SHIFT and WIDTH Together	31	DATA (PSK) Operation	64
NARROW (NAR) One-Touch IF Filter Selection	31	Example of DATA Communications device	64
IF NOTCH Filter Operation		DATA-AFSK (PSK, OLIVIA,	
(SSB/CW/RTTY/DATA/AM Modes)	32	CONTESTIA, RTTY etc.)	65
Digital Noise Reduction (DNR) Operation	33	DATA MODE (PSK, OLIVIA,	
Digital NOTCH Filter (DNF) Operation	34	CONTESTIA, RTTY etc.)	67
Tools for Comfortable and Effective Reception ..	35	Menu Mode	69
RF Gain (SSB/CW/AM Modes)	35	Optional FH-2 Remote Control Switches	102
ATT (Attenuator)	35	Optional MH-36E8J Microphone Switches	103
IPO (Intercept Point Optimization)	36	FC-50 External Automatic Antenna Tuner	104
AGC (Automatic Gain Control)	36	Interconnections to FT-891	104
Adjustable Receiver Audio Filter	37	Setup the FT-891	104
Enhancing Transmit Signal Quality	38	Operation	105
Mic Gain	38	FC-40 External Automatic Antenna Tuner	
Speech Processor (SSB Mode)	38	(for Wire Antenna)	106
Parametric Microphone Equalizer		Interconnections to FT-891	106
(SSB/AM mode)	39	Setup the FT-891	107
Setup of the Parametric Microphone Equalizer	39	Operation	107
Activating the Parametric Microphone Equalizer	40	Auto Active-Tuning Antenna System	
Adjusting the SSB Transmitted Bandwidth		(ATA-120A) Operation	108
(SSB Mode)	41	Interconnections to FT-891	108
Transmitter Convenience Features	42	Setup the FT-891	109
Voice Memory (SSB/AM modes)	42	Tuning Operation	109
Voice Memory Operation	42	Manual Tuning	110
VOX (SSB/AM/FM Modes: Automatic		VL-1000 Linear Amplifier Interconnections	111
TX/RX Switching using Voice Control)	46	Index	112
MONITOR (SSB/CW/AM modes)	47		

CW Mode Operation

The powerful CW operating capabilities of the FT-891 permit operation using an electronic keyer paddle, a “straight key”, or a computer-based keying device.

Setup for Straight Key (and Straight Key Emulation) Operation

Before starting, connect a key line to the rear panel KEY jack.

1. Press and hold the **[BAND(MODE)]** key for one second.

The “MODE SELECT” screen will appear in the display.

2. Rotate the **DIAL** knob to select the “CW” mode.

3. Press the **[F]** key repeatedly to find the “CW SETTING” list screen.

4. Rotate the **MULTI** function knob to select “BK-IN”.

5. Press the **MULTI** function knob to engage the “break-in” system.

6. Press and hold the **[F]** key for one second to exit the “CW SETTING” list screen and resume normal operation.

7. When the key is pressed, the transmitter will automatically be engaged.

8. When the key is released, the receiver audio will return, after a brief delay.

- The CW sidetone audio level may be adjusted by setting “MONITOR” (see page 47).

- To enable the keying operation in LSB/USB mode and send the CW signal without switching to CW mode, change Menu item “07-06 [CW AUTO MODE]”.

- The same frequency may be displayed when switching between SSB mode and CW mode by setting Menu item “07-01 [CW FREQ DISPLAY]”.

- By connecting the FT-891 to a computer, CW can be operated using free or commercially available software and setting Menu item “07-12 [PC KEYING]”.

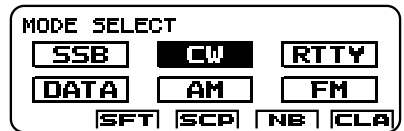
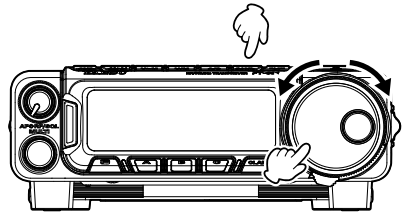
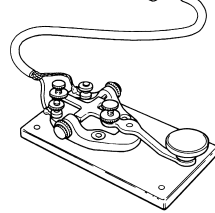
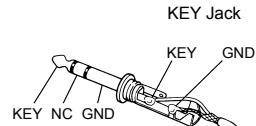
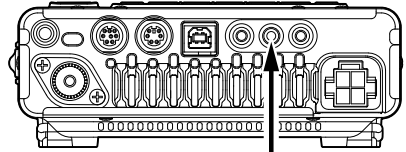

CW Mode Operation

Using the Built-in Electronic Keyer

Before starting, connect the cable from your keyer paddle to the rear panel KEY jack.

1. Press and hold the **[BAND(MODE)]** key for one second.
The “MODE SELECT” screen will appear in the display.
 2. Rotate the **DIAL** knob to select the “CW” mode.
 3. Press the **[F]** key repeatedly to find the “CW SETTING” list screen.
 4. Rotate the **MULTI** function knob to select “BK-IN”.
 5. Press the **MULTI** function knob to engage the “break-in” system.
 6. Rotate the **MULTI** function knob to select “KEYER”.
 7. Press the **MULTI** function knob to engage the built-in Electronic Keyer.
 8. Press and hold the **[F]** key for one second to exit the “CW SETTING” list screen and resume normal operation.
 9. When the keyer paddle is pressed, the transmitter will automatically be engaged.
 10. When the paddle is released, the receiver audio will return, after a brief delay.
- The CW sidetone audio level may be adjusted by setting “MONITOR” (see page 47).
 - To enable the keying operation in LSB/USB mode and send the CW signal without switching to CW mode, change Menu item “07-06 [CW AUTO MODE]”.
 - The same frequency may be displayed when switching between SSB mode and CW mode by setting Menu item “07-01 [CW FREQ DISPLAY]”.
 - By connecting the FT-891 to a computer, CW can be operated using free or commercially available software and setting Menu item “07-12 [PC KEYING]”.

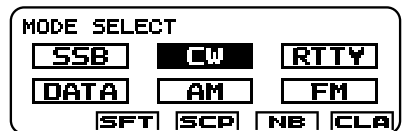
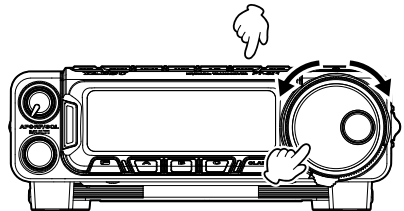
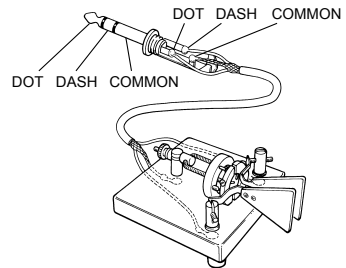
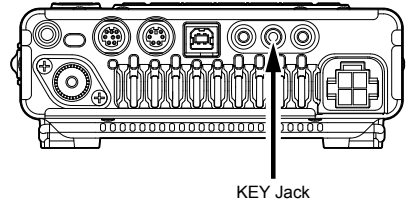

CW Mode Operation

Adjusting the keyer speed

The keyer speed can be adjusted via the “CW SETTING” list screen.

1. Press the [F] key repeatedly to find the “CW SETTING” list screen.
2. Rotate the **MULTI** function knob to select “SPEED”.
3. Press the **MULTI** function knob, the keying speed pop-up screen will appear.
4. Rotate the **MULTI** function knob to set the desired sending speed (4 - 60 WPM).

Default: 20 WPM

5. Press the **MULTI** function knob, then press and hold the [F] key for one second to exit the “CW SETTING” list screen and resume normal operation.

- Keyer speed function may be assigned to the [A], [B] or [C] key. Refer to “Changing the function assigned to the [A]/[B]/[C] keys” in the FT-891 Operating Manual.

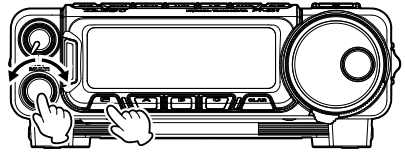

Full Break-in (QSK) Operation

As shipped from the factory, the FT-891 TX/RX system for CW is configured for “Semi-break-in” operation.

However, this setup may be changed to full break-in (QSK) operation by setting Menu item “07-08 [CW BK-IN TYPE]”. With full break-in QSK, the TX/RX switching is quick enough to hear incoming signals in the spaces between the dots and dashes of your transmission.

1. Press and hold in the [F] key for one second to activate the Menu mode.
2. Rotate the **MULTI** function knob to select Menu Mode “07-08 [CW BK-IN TYPE]”.
3. Press the **MULTI** function knob, and then rotate it to set this menu item to “FULL”.
4. When the adjustment is satisfactory, press the **MULTI** function knob.
5. Press the [F] key to save the new setting and exit the Menu mode to normal operation.

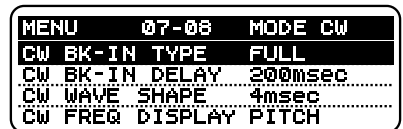
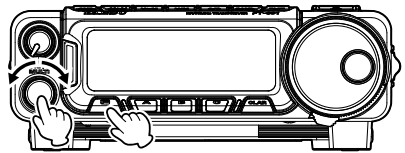

CW Mode Operation

Setting the Keyer Weight (Dot/Dash) Ratio

This Menu item may be used to adjust the dot/dash ratio for the built-in Electronic Keyer. The default weighting is 3:1 (a dash is three times longer than a dot).

1. Press and hold in the [F] key for one second to activate the Menu mode.
2. Rotate the **MULTI** function knob to select Menu Mode “04-03 [CW WEIGHT]”.
3. Press the **MULTI** function knob, and then rotate it to set the weight to the desired value. The available adjustment range is a Dot/Dash ratio of 2.5 - 4.5.

Default: 3.0

4. When the adjustment is satisfactory, press the **MULTI** function knob.
5. Press the [F] key to save the new setting and exit the Menu mode to normal operation.

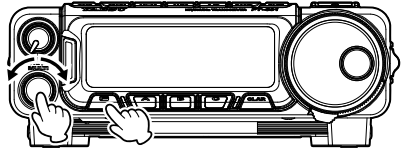

MENU	04-03	KEYER
CW WEIGHT	3.0	
BEACON INTERVAL	OFF	
NUMBER STYLE	1290	
CONTEST NUMBER	1	

Reversing the Keyer Polarity

For left-handed operators in a contest, for example, the polarity can be reversed easily in the Menu mode without changing the keyer connection (the default setting is “NOR”).

1. Press and hold in the [F] key for one second to activate the Menu mode.
2. Rotate the **MULTI** function knob to select Menu Mode “04-02 [KEYER DOT/DASH]”.
3. Press the **MULTI** function knob, and then rotate it to select “REV”.
4. When the adjustment is satisfactory, press the **MULTI** function knob.
5. Press the [F] key to save the new setting and exit the Menu mode to normal operation.

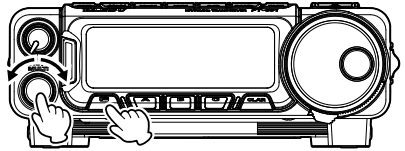

MENU	04-02	KEYER
KEYER DOT/DASH	REV	
CW WEIGHT	3.0	
BEACON INTERVAL	OFF	
NUMBER STYLE	1290	

CW Mode Operation

Selecting the Keyer Operating Mode

The configuration of the Electronic Keyer may be customized independently for the rear panel KEY jack of the FT-891. This permits utilization of Automatic Character Spacing (ACS), if desired.

1. Press and hold in the [F] key for one second to activate the Menu mode.
2. Rotate the **MULTI** function knob to select Menu Mode **"04-01 [KEYER TYPE]"**.
3. Press the **MULTI** function knob, and then rotate it to set the keyer to the desired mode. The available selections are:

OFF: The built-in Electronic Keyer is turned off ("straight key" mode).

BUG: Dots will be generated automatically by the keyer, but dashes must be sent manually.

ELEKEY-A: A code elements ("Dot" or "Dash") are automatically transmitted upon pressing either side of the paddle.

ELEKEY-B: Pressing both sides of the paddle transmits the currently generated "Dash" followed by the "Dot" (or reverse order).

ELEKEY-Y: Pressing both sides of the paddle transmits the currently generated "Dash" followed by the "Dot" (or reverse order). While transmitting the "Dash", the first transmitted "Dot" will not be stored.

ACS: Same as "ELEKEY" except that the spacing between characters is precisely set by the keyer to be the same length as a dash (three dots in length).

Default: ELEKEY-B

4. When the Menu selection is satisfactory, press the **MULTI** function knob.
5. Press the [F] key to save the new setting and exit the Menu mode to normal operation.

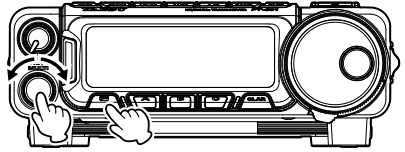

MENU	04-01	KEYER
KEYER TYPE	ELEKEY-B	
KEYER DOT/DASH	NOR	
CW WEIGHT	3.0	
BEACON INTERVAL	OFF	

ACS
OFF

Morse
"E" & "T"

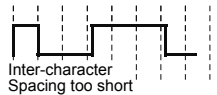

ACS
ON

Morse
"E" & "T"



CW Mode Operation

CW Delay Time Setting

During semi-break-in (not QSK) operation, the hang time of the transmitter, after you have finished sending, may be adjusted to a comfortable value consistent with your sending speed. This is the functional equivalent of the “VOX Delay” adjustment used on voice modes, and the delay may be varied anywhere between 30 msec and 3 seconds via Menu item “07-09 [CW BK-IN DELAY]”.

1. Press and hold in the [F] key for one second to activate the Menu mode.
2. Rotate the **MULTI** function knob to select Menu Mode “07-09 [CW BK-IN DELAY]”.
3. Press the **MULTI** function knob, and then rotate it to adjust the hang time (30 - 3000 msec).

Default: 200 msec

4. When the adjustment is satisfactory, press the **MULTI** function knob.
5. Press the [F] key to save the new setting and exit the Menu mode to normal operation.

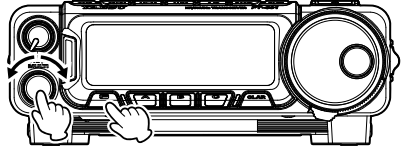

MENU	07-09	MODE CW
CW BK-IN DELAY	200msec	
CW WAVE SHAPE	4msec	
CW FREQ DISPLAY PITCH		
PC KEYING	OFF	

CW Pitch Adjustment

The center frequency of the receiver passband may be adjusted to the preferred CW tone. The pitch of the CW carrier offset may be varied between 300 Hz and 1050 Hz, in 10 Hz steps.

1. Press the [F] key repeatedly to find the “CW SETTING” list screen.
2. Rotate the **MULTI** function knob to select “PITCH”.
3. Press the **MULTI** function knob, the PITCH frequency pop-up screen will appear.
4. Rotate the **MULTI** function knob to adjust the PITCH (300 - 1050 Hz).

Default: 700 Hz

5. Press the **MULTI** function knob, then press and hold the [F] key for one second to exit the “CW SETTING” list screen and resume normal operation.
- CW Pitch function may be assigned to the [A], [B] or [C] key. Refer to “Changing the function assigned to the [A]/[B]/[C] keys” in the FT-891 Operating Manual.

CW Pitch: If the receiver is tuned to an exact “zero beat” on an incoming CW signal, you could not copy it (“Zero beat” implies a 0 Hz tone). Therefore, the receiver is offset several hundred Hz (typically), to produce a beat tone that can be heard. The BFO offset associated with this tuning (that produces the comfortable audio tone) is called the CW Pitch.

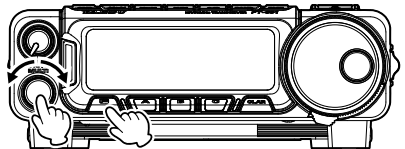

CW SETTING			
SPEED	ZIN	APF	
PITCH	KEYER	BK-IN	
SFT	SCP	NE	CLA

CW Mode Operation

CW Spotting (Zero-Beating)

“Spotting” (zeroing in on a received CW station) is a handy technique to ensure you and the other station are precisely on the same frequency.

The Tuning Offset Indicator in the LCD display may also be observed, so that the receiver frequency can be adjusted to center the incoming station on the pitch corresponding to that of the transmitted signal.

Using the Auto Zeroing System

1. Press the **[F]** key repeatedly to find the “CW SETTING” list screen.
2. Rotate the **MULTI** function knob to select “ZIN”.
3. Press the **MULTI** function knob to cause the receiving frequency to zero-in automatically while receiving a CW signal.
4. Press and hold the **[F]** key for one second to exit the “CW SETTING” list screen and resume normal operation.

- Auto Zeroing function may be assigned to the [A], [B] or [C] key. Refer to “Changing the function assigned to the [A]/[B]/[C] keys” in the FT-891 Operating Manual.

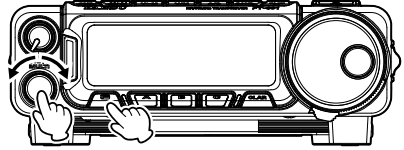

Using the SPOT System

1. Press the **[F]** key repeatedly to find the “FUNCTION-1” list screen.
2. Rotate the **MULTI** function knob to select “MON”.
3. Press the **MULTI** function knob to activate the Monitor function, the Monitor level pop-up screen will appear.
4. Rotate the **MULTI** function knob to adjust the Monitor audio volume.
5. Press the **MULTI** function knob.
6. Press the **[F]** key repeatedly to find the “CW SETTING” list screen.
7. Rotate the **MULTI** function knob to select “ZIN”.

8. While you are pressing and holding the **MULTI** function knob, the tone is output from the speaker.
9. Press and hold the **[F]** key for one second to exit the “CW SETTING” list screen and resume normal operation.

- Spot function may be assigned to the [A], [B] or [C] key. Refer to “Changing the function assigned to the [A]/[B]/[C] keys” in the FT-891 Operating Manual.

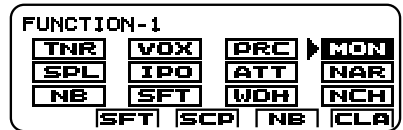
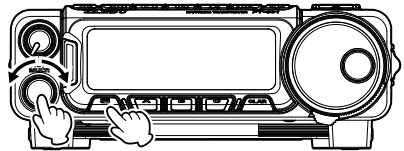

CW Mode Operation

- The displayed frequency on the CW mode normally reflects the “zero beat” frequency of the offset carrier. That is, when receiving a signal at 14.100.00 MHz with a 700 Hz offset, the “zero beat” frequency of that CW carrier would be 14.100.70 MHz; which is what the FT-891 displays, by default. However, the display may be changed to be identical to what would be seen when listening on the USB mode, by using Menu item “**07-11 [CW FREQ DISPLAY]**” and setting it to “FREQ” instead of the default “PITCH” setting.

Audio Peak Filter

1. Press the **[F]** key repeatedly to find the “CW SETTING” list screen.
2. Rotate the **MULTI** function knob to select “APF”.
3. Press the **MULTI** function knob, then rotate it to set the “APF” action to a comfortable level (-250 - +250 Hz).

Default: +250 Hz

- The APF bandwidth can be selected from NARROW/MEDIUM/WIDE via the Menu item “**12-01 [APF WIDTH]**”.
 - 4. To cancel the APF action, press the **MULTI** function knob, then press and hold the **[F]** key for one second to exit the “CW SETTING” list screen and resume normal operation.
- The APF may only be activated while the transceiver is in CW mode.
 - Audio Peak Filter function may be assigned to the **[A]**, **[B]** or **[C]** key. Refer to “Changing the function assigned to the **[A]/[B]/[C]** keys” in the FT-891 Operating Manual.

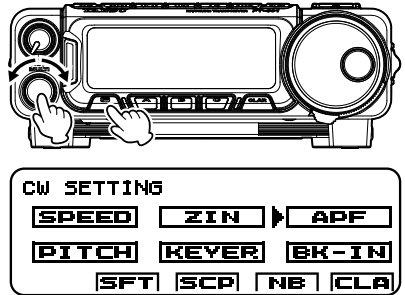

CW Mode Operation

Contest Memory Keyer

The CW message capability of the FT-891 may be utilized from the Front Control Panel, or the optional FH-2 Remote Control Keypad, which plugs into the rear panel REM/ALC jack.

Message Memory

Five CW memory channels, capable of retaining 50 characters each, are provided (the CW memory uses the PARIS standard for characters and word length).

Example: CQ CQ CQ DE W6DXC K (19 characters)

-. -. -. -. -. -. -. . . - - -. -. -. -. -. .
(C) (Q) (C) (Q) (C) (Q) (D) (E) (W) (6) (D) (X) (C) (K)

Storing a CW Message into Memory using a Keyer Paddle

1. First, set the message entry method to keyer entry. To activate the Menu mode, press and hold the [F] key in for one second.
2. Rotate the **MULTI** function knob to select the CW Memory Register into which you wish to store the message; for now, we are just setting the message entry technique to (Keyer entry).

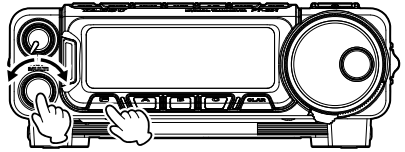

MENU	04-07	KEYER
CW MEMORY 1		TEXT
CW MEMORY 2		TEXT
CW MEMORY 3		TEXT
CW MEMORY 4		TEXT

“04-07 [CW MEMORY 1]”

“04-08 [CW MEMORY 2]”

“04-09 [CW MEMORY 3]”

“04-10 [CW MEMORY 4]”

“04-11 [CW MEMORY 5]”

MENU	04-07	KEYER
CW MEMORY 1		MESSAGE
CW MEMORY 2		TEXT
CW MEMORY 3		TEXT
CW MEMORY 4		TEXT

3. Press the **MULTI** function knob briefly, and then rotate it to set the selected CW Memory Register to “MESSAGE”. If you want to use a keyer paddle for message entry on all five memories, set Menu items #04-07 to #04-11 to “MESSAGE”.
4. Press the **MULTI** function knob to save the new setting.
5. Press the [F] key to exit to normal operation.

PARIS Word Length: By convention among CW and Amateur operators (utilized by ARRL and others), the length of one “word” of CW is defined as the length of the Morse Code characters spelling the word “PARIS”. This character (dot/dash/space) length is used for the specific definition of code speed in “words” per minute.

CW Mode Operation

Message Memory Programming from the FT-891 Control Panel (Using a Keyer Paddle)

1. Set the operating mode to CW.
2. Set the “BK-IN” feature to “OFF”.
3. Turn the internal Electronic Keyer “ON”.
4. Press the [F] key repeatedly to find the “REC SETTING” list screen.

NOTE: This screen may be enabled/disabled via Menu Mode “05-11 [REC SETTING]”.

5. Rotate the **MULTI** function knob to select “MEM”.
6. Press the **MULTI** function knob. A blinking “REC” icon will appear in the display.
7. Rotate the **MULTI** function knob to select any numbered [CH1] through [CH5].
8. Press the **MULTI** function knob to begin the memory storage process, and the “REC” icon will glow steadily.
9. Send the desired message using the keyer paddle.

NOTE: If you do not start keying within ten seconds, the memory storage process will be canceled.

10. Press the **MULTI** function knob once more at the end of the message. Up to 50 characters may be stored in each of the five memories.
11. Press and hold the [F] key for one second to exit the “REC SETTING” list screen and resume normal operation.

NOTE: Care must be exercised when sending to ensure that the spaces between letters and words are accurately done; if the timing is off, the spacing may not come out right in the stored message. For ease in setting up the keyer memories, we recommend setting Menu item “04-01 [KEYER TYPE]” to “ACS” (Automatic Character Spacing) while programming the keyer memories.

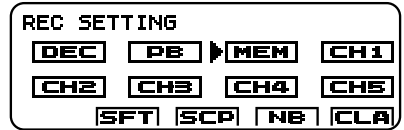
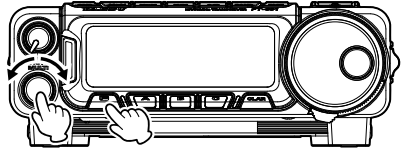

CW Mode Operation

Message Memory Programming with the Optional FH-2 (Using the Keyer Paddle)

1. Set the operating mode to CW.
2. Set the “BK-IN” feature to “OFF”.
3. Turn the internal Electronic Keyer “ON”.
4. Press the **[MEM]** key on the FH-2. A blinking “REC” icon will appear in the display.
5. Press any of the FH-2 keys numbered **[1]** through **[5]** to begin the memory storage process, and the “REC” icon will glow steadily.
6. Send the desired message using the keyer paddle.

NOTE: If you do not start keying within ten seconds, the memory storage process will be canceled.

7. Press the **[MEM]** key on the FH-2 once more at the end of your message. Up to 50 characters may be stored in each of the five memories.

NOTE: Care must be exercised when sending to ensure that the spaces between letters and words are accurately done; if the timing is off, the spacing may not come out right in the stored message. For ease in setting up the keyer memories, we recommend setting Menu item “**04-01 [KEYER TYPE]**” to “ACS” (Automatic Character Spacing) while programming the keyer memories.

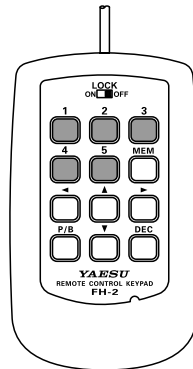
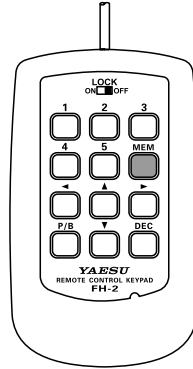

CW Mode Operation

Checking the CW Memory Contents from the FT-891 Front Control Panel

1. Set the operating mode to CW.
2. Set the “BK-IN” feature to “OFF”.
3. Press the [F] key to find the “FUNCTION-1” list screen.
4. Rotate the **MULTI** function knob to select “MON”.
5. Press the **MULTI** function knob, the Monitor level pop-up screen will appear.
6. Rotate the **MULTI** function knob to set the Monitor volume level (0 - 100).
7. Press the **MULTI** function knob or the [F] key.
8. Press the [F] key to find the “REC SETTING” list screen.

NOTE: This screen may be enabled/disabled via Menu Mode “05-11 [REC SETTING]”.

9. Rotate the **MULTI** function knob to select a memory [CH1] - [CH5] that was previously recorded.
10. Press the **MULTI** function knob to hear the CW message played in the sidetone monitor. No RF energy will be transmitted.
11. Press and hold the [F] key for one second to exit the “REC SETTING” list screen and resume normal operation.

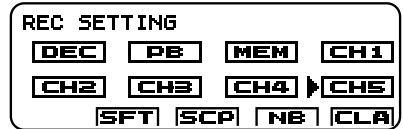
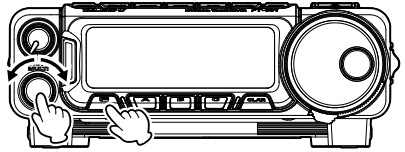

CW Mode Operation

Checking the CW Memory Contents with the Optional FH-2

1. Set the operating mode to CW.
2. Set the "BK-IN" feature to "OFF".
3. Press the [F] key to find the "FUNCTION-1" list screen.
4. Rotate the **MULTI** function knob to select "MON".
5. Press the **MULTI** function knob, the Monitor level pop-up screen will appear.
6. Rotate the **MULTI** function knob to set the Monitor volume level (0 - 100).
7. Press the **MULTI** function knob or the [F] key.
8. Press and hold the [F] key for one second to exit the "FUNCTION-1" list screen and resume normal operation.
9. Press the FH-2 [CH1] - [CH5] key to select a previously recorded memory. The CW message will be played in the sidetone monitor. No RF energy will be transmitted.

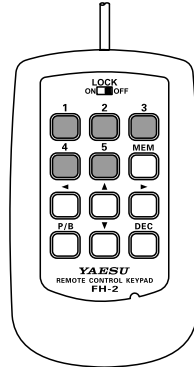
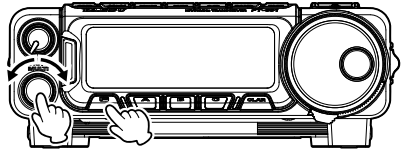

CW Mode Operation

Playback the CW Message On-The-Air using the FT-891 Display Control Panel

1. Set the operating mode to CW.
2. Set the "BK-IN" feature to "ON".
3. Press the [F] key to find the "REC SETTING" list screen.

NOTE: This screen may be enabled/disabled via Menu Mode "05-11 [REC SETTING]".

4. Rotate the **MULTI** function knob to select a previously recorded CW memory [CH1] - [CH5].
5. Press the **MULTI** function knob, the CW message programmed in the selected Memory Register will be transmitted on the air.
6. Press and hold the [F] key for one second to exit the "REC SETTING" list screen and resume normal operation.

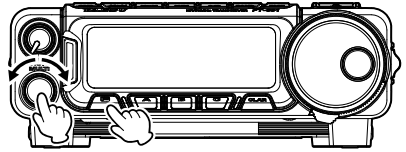

Playback the CW Message On-The-Air using the Optional FH-2

1. Set the operating mode to CW.
2. Set the "BK-IN" feature to "ON".
3. Press the FH-2 [CH1] - [CH5] key, depending on which CW Memory Register message you wish to transmit. The programmed message will be transmitted on the air.

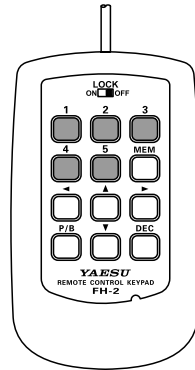

CW Mode Operation

Text Memory

The five channels of CW message memory (up to 50 characters each) may also be programmed using a text-entry technique. This method is somewhat slower than sending the message directly from the keyer paddle, but accuracy of character spacing is ensured. Be sure to enter the character “}” at the end of the text message.

Example 1: CQ CQ CQ DE W6DXC K} (20 characters)

The sequential Contest Number (“Count up”) feature is another powerful feature that may be utilized within the CW Memory Keyer by entering the # symbol.

Example 2: 599 10 200 # K} (15 characters)

Text Memory Storage

1. Press and hold in the [F] key for one second to activate the Menu mode.
2. First, set the message entry method to Text Entry. Rotate the **MULTI** function knob to select the CW Memory Register into which you wish to store the message using the Text Entry method.

“04-07 [CW MEMORY 1]”

“04-08 [CW MEMORY 2]”

“04-09 [CW MEMORY 3]”

“04-10 [CW MEMORY 4]”

“04-11 [CW MEMORY 5]”

3. Press the **MULTI** function knob, and then rotate it to set the selected CW Memory Register to “TEXT”. If you want to use text message entry on all memories, set all five Menu items (#04-07 to #04-11) to “TEXT”.
4. Press the **MULTI** function knob to save the new setting.
5. Press the [F] key to exit to normal operation.

The following texts are programmed to MEMORY 4 and MEMORY 5 as the factory default:

MEMORY 4: DE FT-891 K}

MEMORY 5: R 5NN K}

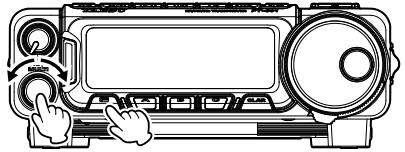

MENU	04-07	KEYER
CW MEMORY 1		TEXT
CW MEMORY 2		TEXT
CW MEMORY 3		TEXT
CW MEMORY 4		TEXT

CW Mode Operation

Text Message Programming from the FT-891 Control Panel

1. Set the operating mode to CW.
2. Press the [F] key repeatedly, to find the "REC SETTING" list screen.

NOTE: This screen may be enabled/disabled via Menu Mode "05-11 [REC SETTING]".

3. Rotate the **MULTI** function knob to select "MEM".
4. Press the **MULTI** function knob. A blinking "REC" icon will appear in the display.
5. Rotate the **MULTI** function knob to select any channel [CH1] through [CH5].
6. Press the **MULTI** function knob. The "CW TEXT" screen will appear.
7. Press the [B](EDT) key. The text input screen will appear.
8. Rotate the **MULTI** function knob to select the letters, numbers, or symbols of the desired label, then press the **MULTI** function knob.
9. Press the **MULTI** function knob.
10. Repeat step 8 and 9 to program the remaining letters, numbers, or symbols of the desired text. Up to 50 characters may be stored in each of the five memories.
 - Rotate the **MULTI** function knob to set the cursor position and press the [B](CE) key to erase and input characters.
11. When text entry is complete, press the [C](ENT) key.
12. Press the [A](BCK) key to exit the text input screen.
13. Press and hold the [F] key for one second to exit the "REC SETTING" list screen and resume normal operation.

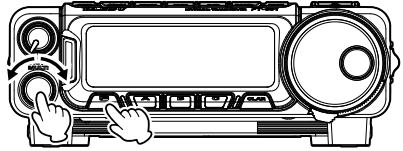

CW Mode Operation

Text Message Programming with the Optional FH-2

1. Set the operating mode to CW.
2. Press the **[MEM]** key on the FH-2. A blinking "REC" icon will appear in the display.
3. Press any of the FH-2 keys numbered [1] through [5], to select the desired CW Memory Register that you wish to program with text.
4. Press the **[MEM]** key on the FH-2. The text input screen will appear.
5. Rotate the **MULTI** function knob to select the letters, numbers, or symbols of the desired label, then press the **MULTI** function knob.
6. Press the **MULTI** function knob.
7. Repeat step 5 and 6 to program the remaining letters, numbers, or symbols of the desired text. Up to 50 characters may be stored in each of the five memories.
 - Rotate the **MULTI** function knob to set the cursor position and press the **[B](CE)** key to erase and input characters.
8. When the message is complete, add the "}" character at the end to signify the termination of the message.
9. When the text entry is complete, press the **[B](ENT)** key.
10. Press and hold the FH-2 **[MEM]** key for one second to exit the text input screen and resume normal operation.

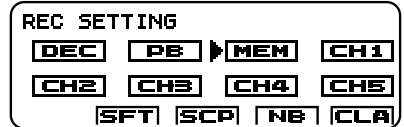
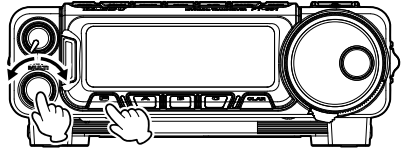

CW Mode Operation

Checking the CW Memory Contents from the FT-891 Front Control Panel

1. Set the operating mode to CW.
2. Set the "BK-IN" feature to "OFF".
3. Press the [F] key repeatedly, to find the "FUNCTION-1" list screen.
4. Rotate the **MULTI** function knob to select "MON".
5. Press the **MULTI** function knob, the Monitor level pop-up screen will appear.
6. Rotate the **MULTI** function knob to set the Monitor volume level (0 - 100).
7. Press the **MULTI** function knob or the [F] key.
8. Press the [F] key repeatedly, to find the "REC SETTING" list screen.

NOTE: This screen may be enabled/disabled via Menu Mode "05-11 [REC SETTING]".

9. Rotate the **MULTI** function knob to select a memory [CH1] - [CH5] that was previously recorded.
10. Press the **MULTI** function knob to hear the CW message played in the sidetone monitor. No RF energy will be transmitted.
11. Press and hold the [F] key for one second to exit the "REC SETTING" list screen and resume normal operation.

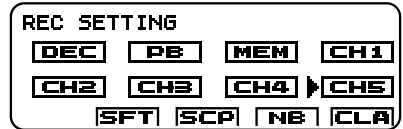
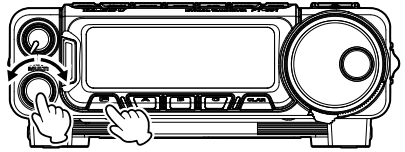

CW Mode Operation

Checking the CW Memory Contents with the Optional FH-2

1. Set the operating mode to CW.
2. Set the "BK-IN" feature to "OFF".
3. Press the [F] key repeatedly, to find the "FUNCTION-1" list screen.
4. Rotate the **MULTI** function knob to select "MON".
5. Press the **MULTI** function knob, the Monitor level pop-up screen will appear.
6. Rotate the **MULTI** function knob to set the Monitor volume level (0 - 100).
7. Press the **MULTI** function knob or the [F] key.
8. Press and hold the [F] key for one second to exit the "FUNCTION-1" list screen and resume normal operation.
9. Press the FH-2 [CH1] - [CH5] key to select a previously recorded memory. The CW message will be played in the sidetone monitor. No RF energy will be transmitted.

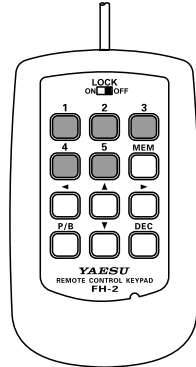
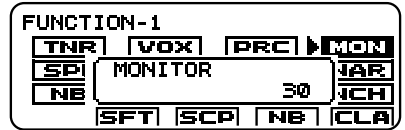
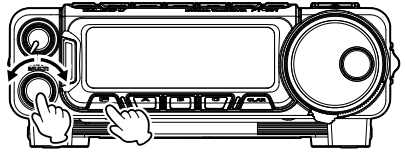

CW Mode Operation

Playback the CW Message On-The-Air using the FT-891 Display Control Panel

1. Set the operating mode to CW.
2. Set the "BK-IN" feature to "ON".
3. Press the [F] key repeatedly, to find the "REC SETTING" list screen.

NOTE: This screen may be enabled/disabled via Menu Mode "05-11 [REC SETTING]".

4. Rotate the **MULTI** function knob to select a previously recorded CW memory [CH1] - [CH5].
5. Press the **MULTI** function knob, the CW message programmed in the selected Memory Register will be transmitted on the air.
6. Press and hold the [F] key for one second to exit the "REC SETTING" list screen and resume normal operation.

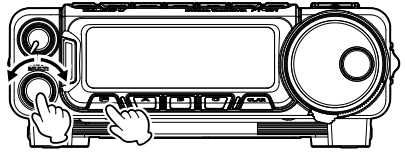

Playback the CW Message On-The-Air using the Optional FH-2

1. Set the operating mode to CW.
2. Set the "BK-IN" feature to "ON".
3. Press the FH-2 [CH1] - [CH5] key, depending on which CW Memory Register message you wish to transmit. The programmed message will be transmitted on the air.

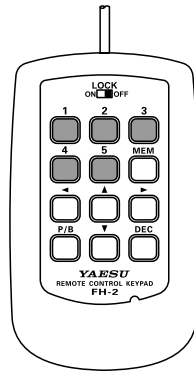

CW Mode Operation

Contest Number Programming

Use this process when beginning a contest, or if the count becomes out of sync with the contact number in the middle of a contest.

1. Press and hold in the [F] key for one second to activate the Menu mode.
2. Rotate the **MULTI** function knob to select Menu Mode “**04-06 [CONTEST NUMBER]**”. The current contest number will appear on the LCD display.
3. Press the **MULTI** function knob, and then rotate it to set the Contest Number to the desired value.
4. Press the **MULTI** function knob to save the new setting.
5. Press the [F] key to exit the Menu mode and resume normal operation.

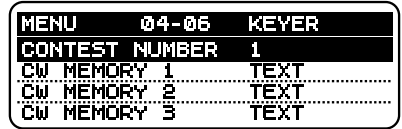
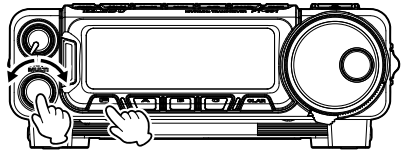

Decrementing the Contest Number

Use this process if the current contest number gets slightly ahead of the actual contact number (in case of a duplicate QSO, for example).

Using the FT-891 Display Control Panel

1. Press the [F] key repeatedly, to find the “REC SETTING” list screen.

NOTE: This screen may be enabled/disabled via Menu Mode “**05-11 [REC SETTING]**”.

2. Rotate the **MULTI** function knob to select “DEC”.
3. Press the **MULTI** function knob. The current Contest Number will be reduced by one.

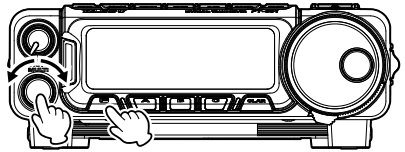

Using the Optional FH-2

Press the FH-2 [DEC] key momentarily. The current Contest Number will be reduced by one. Press the FH-2 [DEC] key as many times as necessary to reach the desired number. If it is reduced too far, use the “Contest Number Programming” technique described previously.

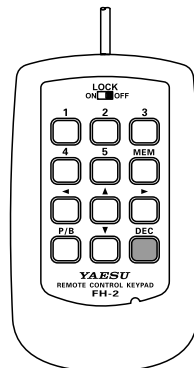

CW Mode Operation

Transmitting in the Beacon Mode

In “Beacon” mode, it is possible to repeatedly transmit any message programmed, either via paddle input, or via the “Text” input method. The time delay between message repeats may be set anywhere between 1 and 690 seconds (1 - 240 sec (1 sec/step) or 270 - 690 sec (30 sec/step)) via Menu Mode “**04-04 [BEACON INTERVAL]**”. To stop the message from repeating in “Beacon” mode, set this Menu Mode to “OFF”.

1. Press and hold in the [F] key for one second to activate the Menu mode.
2. Rotate the **MULTI** function knob to select Menu Mode “**04-04 [BEACON INTERVAL]**”. The current interval time will appear on the LCD display.
3. Press the **MULTI** function knob, and then rotate it to set the interval time to the desired value.
4. Press the **MULTI** function knob to save the new setting.
5. Press the [F] key to exit the Menu mode and resume normal operation.

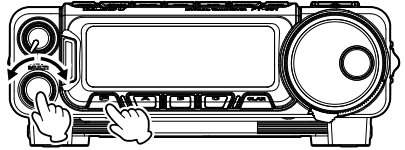

MENU	04-04	KEYER
BEACON INTERVAL	OFF	
NUMBER STYLE	1290	
CONTEST NUMBER	1	
CW MEMORY 1	TEXT	

To transmit the message using the FT-891 Display Control Panel:

1. Set the “BK-IN” feature to “ON”
2. Either Full-break-in or Semi-break-in will be engaged, depending on the setting of Menu Mode “**07-08 [CW BK-IN TYPE]**”.
3. Press the [F] key repeatedly, to find the “REC SETTING” list screen.
NOTE: This screen may be enabled/disabled via Menu Mode “**05-11 [REC SETTING]**”.
4. Rotate the **MULTI** function knob to select a [CH1] - [CH5].
5. Press the **MULTI** function knob. Repetitive transmission of the Beacon message will begin.

To transmit the message using the Optional FH-2:

1. Set the “BK-IN” feature to “ON”
2. Either Full-break-in or Semi-break-in will be engaged, depending on the setting of Menu Mode “**07-08 [CW BK-IN TYPE]**”.
3. Press an FH-2 [1] - [5] key. Repetitive transmission of the Beacon message will begin.

FM Mode Operation

Basic Operation

1. Press and hold the **[BAND(MODE)]** key for one second.
The “MODE SELECT” screen will appear in the display.
2. Rotate the **DIAL** knob to select the “FM” mode.
3. Set the transceiver to the desired frequency.
4. Press the microphone PTT switch to transmit. Speak into the microphone in a normal voice level. Release the PTT switch to return to receive.

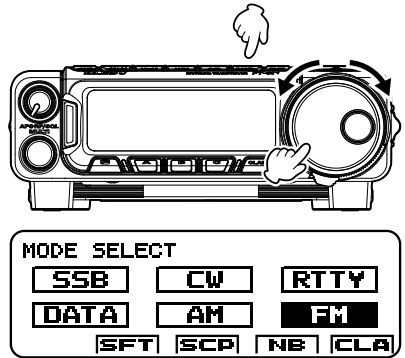

- Change the **MULTI** function knob frequency step, follow the below procedure:
 1. Press and hold in the **[F]** key for one second.
 2. Rotate the **MULTI** function knob to select Menu Mode “**14-07 [FM CH STEP]**”.
 3. Press the **MULTI** function knob, and then rotate it to select one of the frequency steps in the following order.
5 kHz, 6.25 kHz, 10 kHz, 12.5 kHz, 15 kHz, 20 kHz, 25 kHz
 4. Press the **MULTI** function knob to save the new setting.
 5. Press the **[F]** key to exit the Menu mode and resume normal operation.
- Microphone gain may be adjusted via Menu Mode “**16-09 [FM MIC GAIN]**”. At the factory, a default level has been programmed that should be satisfactory for most situations. To change the microphone gain, follow the below procedure:
 1. Press and hold in the **[F]** key for one second.
 2. Rotate the **MULTI** function knob to select Menu Mode “**16-09 [FM MIC GAIN]**”.
 3. Press the **MULTI** function knob, and then rotate it to adjust the microphone gain.
 4. Press the **MULTI** function knob to save the new setting.
 5. Press the **[F]** key to exit the Menu mode and resume normal operation.
- FM is only used in the 28 MHz and 50 MHz Amateur bands covered by the FT-891. Please do not use FM on any other bands.

FM Mode Operation

Repeater Operation

The FT-891 may be utilized on 29 MHz and 50 MHz repeaters.

1. Rotate the **DIAL** to set the FT-891 to the desired repeater output frequency (downlink from the repeater).
2. Press the **[F]** key repeatedly, to find the “FM SETTING” list screen.

NOTE: This screen may be enabled/disabled via Menu Mode “05-10 [FM SETTING]”.

3. Rotate the **MULTI** function knob to select **[T/DCS]**, then press the **MULTI** function knob.
4. Rotate the **MULTI** function knob to select the desired CTCSS mode. If the repeater requires an uplink encoding tone, select “CTCSS ENC”. To enable both uplink and downlink encode/decode operation, choose “CTCSS ENC/DEC”.
5. Press the **MULTI** function knob to save the new setting.
6. Rotate the **MULTI** function knob to select **[TONE]**, and then press the **MULTI** function knob.
7. Rotate the **MULTI** function knob to select the desired CTCSS Tone to be used. A total of 50 standard CTCSS tones are provided (see the CTCSS Tone Chart).

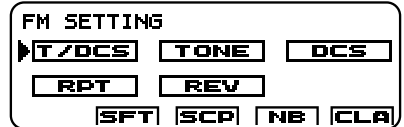
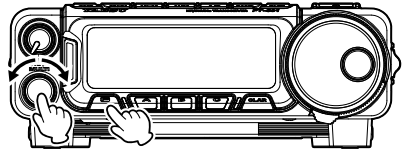

CTCSS Tone Frequency (Hz)									
67.0	69.3	71.9	74.4	77.0	79.7	82.5	85.4	88.5	91.5
94.8	97.4	100.0	103.5	107.2	110.9	114.8	118.8	123.0	127.3
131.8	136.5	141.3	146.2	151.4	156.7	159.8	162.2	165.5	167.9
171.3	173.8	177.3	179.9	183.5	186.2	189.9	192.8	196.6	199.5
203.5	206.5	210.7	218.1	225.7	229.1	233.6	241.8	250.3	254.1

8. Press the **MULTI** function knob to save the new setting
9. Rotate the **MULTI** function knob to select **[RPT]**, then press the **MULTI** function knob.
10. Rotate the **MULTI** function knob to select the desired repeater shift direction. The selections are:

“SIMP” (simplex) / “[+]” (plus shift) / “[-]” (minus shift)

Where “SIMP” represents “Simplex” operation (not used on a repeater).

11. Press the **MULTI** function knob to save the new setting.
 12. Press and hold the **[F]** key for one second to exit the “FM SETTING” list screen and resume normal operation.
 13. Press and hold the microphone PTT switch to begin transmitting. You will observe that the transmit frequency is shifted corresponding to the programming set up in the previous steps. Speak into the microphone in a normal voice level. Release the PTT switch to return to the receive mode.
- The conventional repeater shift used on 29 MHz is 100 kHz, while on the 50 MHz band the shift may vary between 500 kHz and 1.7 MHz (or more). To program the proper repeater shift, use Menu Mode “09-04 [RPT SHIFT 28MHz]” (28 MHz), and “09-05 [RPT SHIFT 50MHz]” (50 MHz) as appropriate.

FM Mode Operation

Tone Squelch Operation

The “Tone Squelch” may be activated to silence the receiver until an incoming signal modulated with a matching CTCSS tone is received. The receiver squelch will then open only when a signal with the selected CTCSS tone is received.

1. Press and hold the **[BAND(MODE)]** key for one second.

The “MODE SELECT” screen will appear in the display.

2. Rotate the **DIAL** knob to select the “FM” mode.
3. Press the **[F]** key repeatedly, to find the “FM SETTING” list screen.

NOTE: This screen may be enabled/disabled via Menu Mode “05-10 **[FM SETTING]**”.

4. Rotate the **MULTI** function knob to select **[T/DCS]**, then press the **MULTI** function knob.
5. If CTCSS Tone operation is desired, rotate the **MULTI** function knob to select “CTCSS ENC/DEC”, then press the **MULTI** function knob.
6. Press the **MULTI** function knob to save the new setting.
7. Rotate the **MULTI** function knob to select **[TONE]**, and then press the **MULTI** function knob.
8. Rotate the **MULTI** function knob to select the desired CTCSS Tone to be used. A total of 50 standard CTCSS tones are provided (see the CTCSS Tone Chart).

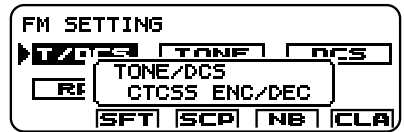
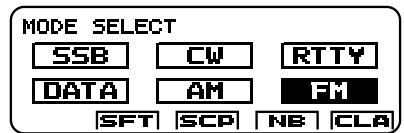
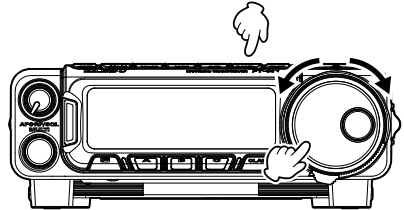

CTCSS Tone Frequency (Hz)									
67.0	69.3	71.9	74.4	77.0	79.7	82.5	85.4	88.5	91.5
94.8	97.4	100.0	103.5	107.2	110.9	114.8	118.8	123.0	127.3
131.8	136.5	141.3	146.2	151.4	156.7	159.8	162.2	165.5	167.9
171.3	173.8	177.3	179.9	183.5	186.2	189.9	192.8	196.6	199.5
203.5	206.5	210.7	218.1	225.7	229.1	233.6	241.8	250.3	254.1

9. Press the **MULTI** function knob to save the new setting.
10. Press and hold the **[F]** key for one second to exit the “FM SETTING” list screen and resume normal operation.

To set the Tone Squelch Operation to “OFF”:

1. Press the **[F]** key repeatedly, to find the “FM SETTING” list screen.
2. Rotate the **MULTI** function knob to select **[T/DCS]**, then press the **MULTI** function knob.
3. Press and hold the **[F]** key for one second to exit the “FM SETTING” list screen and resume normal operation.

FM Mode Operation

DCS Operation

The “DCS” may be activated to silence the receiver until an incoming signal modulated with a matching DCS code is received. The receiver squelch will then open only when a signal with the selected DCS code is received.

1. Press and hold the **[BAND(MODE)]** key for one second.

The “MODE SELECT” screen will appear in the display.

2. Rotate the **DIAL** knob to select the “FM” mode.
3. Press the **[F]** key repeatedly, to find the “FM SETTING” list screen.

NOTE: This screen may be enabled/disabled via Menu Mode “05-10 [FM SETTING]”.

4. Rotate the **MULTI** function knob to select **[T/DCS]**, then press the **MULTI** function knob.
5. If DCS operation is desired, rotate the **MULTI** function knob to select “DCS”, then press the **MULTI** function knob.
6. Press the **MULTI** function knob to save the new setting.
7. Rotate the **MULTI** function knob to select **[DCS]**, and then press the **MULTI** function knob.
8. Rotate the **MULTI** function knob to select the desired DCS Code to be used. A total of 104 DCS codes are provided (see the DCS Code Chart).

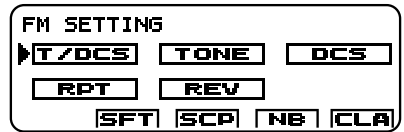
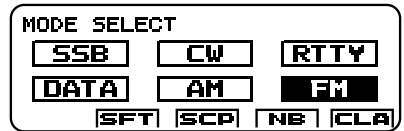
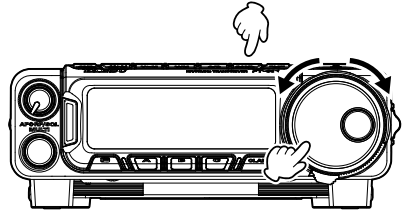

DCS Code														
023	025	026	031	032	036	043	047	051	053	054	065	071	072	073
074	114	115	116	122	125	131	132	134	143	145	152	155	156	162
165	172	174	205	212	223	225	226	243	244	245	246	251	252	255
261	263	265	266	271	274	306	311	315	325	331	332	343	346	351
356	364	365	371	411	412	413	423	431	432	445	446	452	454	455
462	464	465	466	503	506	516	523	526	532	546	565	606	612	624
627	631	632	654	662	664	703	712	723	731	732	734	743	754	-

9. Press the **MULTI** function knob to save the new setting.
10. Press and hold the **[F]** key for one second to exit the “FM SETTING” list screen and resume normal operation.

To set the DCS Operation to “OFF”:

1. Press the **[F]** key repeatedly, to find the “FM SETTING” list screen.
2. Rotate the **MULTI** function knob to select **[T/DCS]**, and then press the **MULTI** function knob.
3. Press and hold the **[F]** key for one second to exit the “FM SETTING” list screen and resume normal operation.

Interference Rejection

CONTOUR Control Operation

The Contour filter system provides a gentle perturbation of the IF filter passband. The Contour is set to either suppress, or boost specific frequency components, and thus enhance the sound and readability of a received signal.

1. Press the **[F]** key repeatedly, to find the “FUNCTION-2” list screen.
2. Rotate the **MULTI** function knob to select “CNT”.
3. Press the **MULTI** function knob, and then rotate it to achieve the most natural sounding audio reproduction of the incoming signal.
4. When the adjustment is completed, press and hold the **[F]** key for one second to exit the “FUNCTION-2” list screen and resume normal operation.

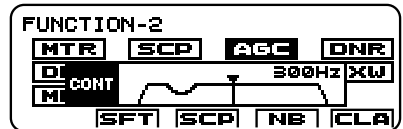
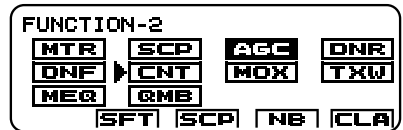
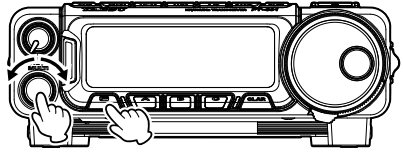

- To set the CONTOUR Operation will be set to “OFF”:
 1. Press the **[F]** key repeatedly, to find the “FUNCTION-2” list screen.
 2. Rotate the **MULTI** function knob to select **[CNT]**, then press the **MULTI** function knob.
 3. Press and hold the **[F]** key for one second to exit the “FUNCTION-2” list screen and resume normal operation.
- CONTOUR function may be assigned to the **[A]**, **[B]** or **[C]** key. Refer to “Changing the function assigned to the **[A]/[B]/[C]** keys” in the FT-891 Operating Manual.
- The Contour function attenuation and bandwidth can be set in Menu Mode “**12-02 [CONTOUR LEVEL]**” and “**12-03 [CONTOUR WIDTH]**” (refer to the instructions on the below).

Refer to Figure (B), this illustrates a “dip” in the center of the Contour filter passband. The Contour filter places a low-Q “notch” in the passband, corresponding to the settings of Menu Mode “**12-02 [CONTOUR LEVEL]**” and “**12-03 [CONTOUR WIDTH]**”. Counter-clockwise rotation of the **MULTI** function knob causes the notch to move toward a lower frequency within the passband, while clockwise rotation causes the notch to move toward a higher frequency within the passband.

By removing interference or unwanted frequency components of the incoming signal, it is possible to make the desired signal rise out of the background noise/interference, and significantly enhance intelligibility.

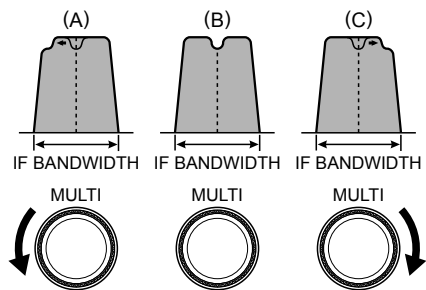

Interference Rejection

WIDTH (IF DSP Bandwidth) Tuning (SSB/CW/RTTY/DATA Modes)

The IF WIDTH tuning system allows the width of the DSP IF passband to be varied, this may reduce or eliminate interference.

Moreover, the bandwidth may actually be *expanded* from the default setting, this may enhance incoming signal fidelity when interference on the band is low.

1. Press the [F] key repeatedly, to find the "FUNCTION-1" list screen.
2. Rotate the **MULTI** function knob to select "WDH".
3. Press the **MULTI** function knob, and then rotate it counter-clockwise to narrow the bandwidth and reduce interference.
 - To increase the bandwidth, rotate the knob clockwise.
4. When the adjustment is completed, press the **MULTI** function knob.
5. Press and hold the [F] key for one second to exit the "FUNCTION-1" list screen and resume normal operation.

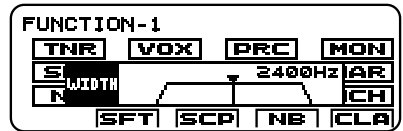
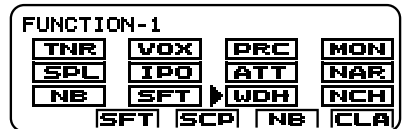
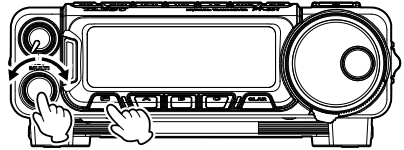

- To set the IF WIDTH Operation to "OFF":
 1. Press the [F] key repeatedly, to find the "FUNCTION-1" list screen.
 2. Rotate the **MULTI** function knob to select "WDH", and then press the **MULTI** function knob.
 3. Press and hold the [F] key for one second to exit the "FUNCTION-1" list screen and resume normal operation.
- WIDTH function may be assigned to the [A], [B] or [C] key. Refer to "Changing the function assigned to the [A]/[B]/[C] keys" in the FT-891 Operating Manual.

Referring to Figure (B), the default bandwidth of the SSB mode is illustrated.

By rotating the **MULTI** function knob to the left, the bandwidth will narrow (see Figure (A)), while rotation of the **MULTI** function knob to the right, will increase the bandwidth as depicted in Figure (C).

The default bandwidths, and total bandwidth adjustment range, will vary according to the operating mode:

SSB Mode: 1.8 kHz - 3.2 kHz (default: 2.4 kHz).

CW Mode: 500 Hz - 3 kHz (default: 2.4 kHz)

RTTY/DATA (LSB, USB) Modes: 500 Hz - 3 kHz (default: 500 Hz)

AM Mode: Fixed at 9 kHz

FM/DATA-FM Modes: Fixed at 16 kHz

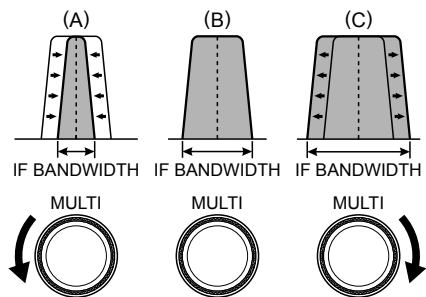

Interference Rejection

Using IF SHIFT and WIDTH Together

The IF SHIFT and Variable IF WIDTH features, together, form a very effective interference fighting filter system.

For example, in Figure (A), interference has appeared on both the high and low sides of the desired signal. By enabling the IF WIDTH Operation, the interference from one side can be eliminated (Figure "B").

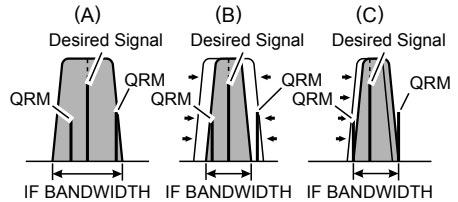

Next, rotate the **MULTI** function knob to re-position the passband (Figure (C)), the interference on the opposite side can be removed, without re-introducing the interference previously eliminated in Figure (B).

- The WIDTH and SHIFT features are the primary tools to use for best interference reduction. After narrowing the bandwidth (WIDTH) and/or adjusting the center of the passband (SHIFT), the Contour control may then be activated to provide additional signal-enhancement benefits on the net residual bandwidth. Even more, the IF NOTCH Filter (described later) may also be used, in conjunction with these filter systems, to significant advantage.

NARROW (NAR) One-Touch IF Filter Selection

1. Press the [F] key repeatedly, to find the "FUNCTION-1" list screen.
2. Rotate the **MULTI** function knob to select "NAR".
3. Press the **MULTI** function knob to enable one-touch, selection of the mode-specific, narrow IF DSP filter, that does not require resetting the WIDTH/SHIFT bandwidth control.

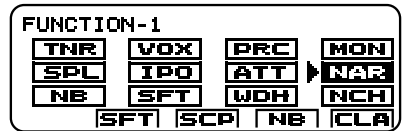
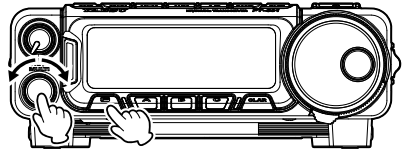

4. Pressing the **MULTI** function knob once more returns the bandwidth control to the WIDTH/SHIFT system.

The factory default bandwidths are:

Operating Mode	Enable/Desable the NARROW Function	
	Enable	Desable
SSB	200 Hz - 1.8 kHz* (1.5 kHz)	1.8 - 3.2 kHz* (2.4 kHz)
CW	50 - 500 Hz* (500 Hz)	500 Hz - 3.0 kHz* (2.4 kHz)
RTTY/DATA (LSB, USB)	50 - 500 Hz* (300 Hz)	500 Hz - 3.0 kHz* (500 Hz)
AM	6 kHz	9 kHz
FM/DATA (FM)	9 kHz	16 kHz

*: Depends on the [WIDTH] setting / (): Default Bandwidth

- NARROW function may be assigned to the [A], [B] or [C] key. Refer to "Changing the function assigned to the [A]/[B]/[C] keys" in the FT-891 Operating Manual.

Interference Rejection

IF NOTCH Filter Operation (SSB/CW/RTTY/DATA/AM Modes)

The IF NOTCH filter is a highly effective system that can reduce or eliminate an interfering beat note or other carrier signal from inside the receiver passband.

1. Press the **[F]** key repeatedly, to find the “FUNCTION-1” list screen.
2. Rotate the **MULTI** function knob to select “NCH”.
3. Press the **MULTI** function knob, and then rotate it to adjust the “null” position of the Notch filter within the receiver passband.
4. When the adjustment is completed, press the **MULTI** function knob.
5. Press and hold the **[F]** key for one second to exit the “FUNCTION-1” list screen and resume normal operation.

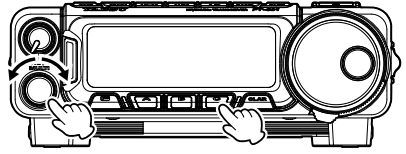

- To set the IF NOTCH to “OFF”:
 1. Press the **[F]** key repeatedly, to find the “FUNCTION-1” list screen.
 2. Rotate the **MULTI** function knob to select “NCH”, then press the **MULTI** function knob.
 3. Press and hold the **[F]** key for one second to exit the “FUNCTION-1” list screen and resume normal operation.
- The bandwidth of the NOTCH filter (either narrow or wide) may be adjusted using Menu item “12-04 [IF NOTCH WIDTH]”. The factory default setting is “WIDE”.
- IF NOTCH function may be assigned to the [A], [B] or [C] key. Refer to “Changing the function assigned to the [A]/[B]/[C] keys” in the FT-891 Operating Manual.

The performance of the IF NOTCH filter is illustrated in Figure (A), where the desired signal and the interfering heterodyne are shown within the IF passband. In Figure (B) the notching effect of the IF NOTCH filter is illustrated as the MULTI knob is rotated to eliminate the interfering heterodyne.

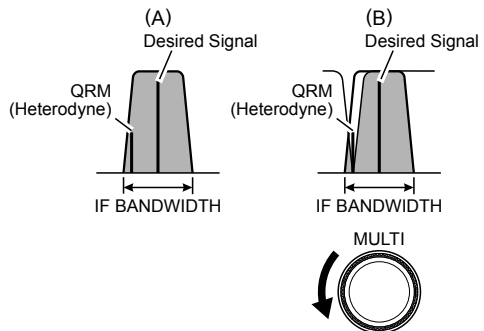

Interference Rejection

Digital Noise Reduction (DNR) Operation

The Digital Noise Reduction (DNR) system is designed to reduce the level of ambient noise found on the HF and 50 MHz bands. The (DNR) system is especially effective during SSB operation. While DNR is activated, rotate the **MULTI** function knob to adjust the DNR level. Any of 15 different noise-reduction algorithms can be selected; each of these algorithms are designed to deal with a different noise profile. You will want to experiment with the DNR system to find the best setting to reduce the noise currently being experienced.

1. Press the **[F]** key repeatedly, to find the "FUNCTION-2" list screen.
 2. Rotate the **MULTI** function knob to select "DNR".
 3. Press the **MULTI** function knob, and then rotate it to choose one of 15 algorithms that best reduces the noise level.
 4. When the adjustment is completed, press the **MULTI** function knob.
 5. Press and hold the **[F]** key for one second to exit the "FUNCTION-2" list screen and resume normal operation.
- To set the DNR to "OFF":
1. Press the **[F]** key repeatedly, to find the "FUNCTION-2" list screen.
 2. Rotate the **MULTI** function knob to select "DNR", then press the **MULTI** function knob.
 3. Press and hold the **[F]** key for one second to exit the "FUNCTION-2" list screen and resume normal operation.
- DNR function may be assigned to the **[A]**, **[B]** or **[C]** key. Refer to "Changing the function assigned to the **[A]**/**[B]**/**[C]** keys" in the FT-891 Operating Manual.

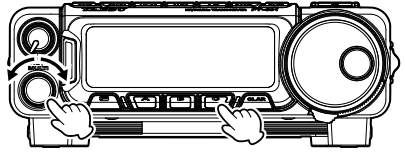

Interference Rejection

Digital NOTCH Filter (DNF) Operation

The Digital NOTCH Filter (DNF) is an effective beat-canceling filter that can null out multiple interfering beat notes inside the receiver passband. Because this is an Automatic Notch feature, there is no adjustment associated with the filter.

Note: If a very strong interfering carrier is encountered, we recommend using the IF NOTCH filter first, because it is the most effective notching tool in the receiver section.

1. Press the **[F]** key repeatedly, to find the “FUNCTION-2” list screen.
2. Rotate the **MULTI** function knob to select “DNF”.
3. Press the **MULTI** function knob.
The Digital Notch Filter will turn on.
4. Press and hold the **[F]** key for one second to exit the “FUNCTION-2” list screen and resume normal operation.

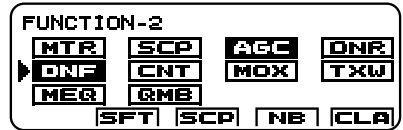
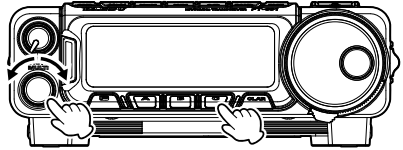

- To set the DNF to “OFF”:
 1. Press the **[F]** key repeatedly, to find the “FUNCTION-2” list screen.
 2. Rotate the **MULTI** function knob to select “DNF”, then press the **MULTI** function knob.
 3. Press and hold the **[F]** key for one second to exit the “FUNCTION-2” list screen and resume normal operation.
- DNF function may be assigned to the **[A]**, **[B]** or **[C]** key. Refer to “Changing the function assigned to the **[A]**/**[B]**/**[C]** keys” in the FT-891 Operating Manual.

Tools for Comfortable and Effective Reception

RF Gain (SSB/CW/AM Modes)

The RF Gain control provides manual adjustment of the receiver RF and IF stages gain, to accommodate the noise and signal strength conditions at the moment.

1. The [RF/SQ] knob should, initially, be rotated clockwise, so that the minimum S-Meter indication is not deflected. This is the point of maximum sensitivity.
 2. Counter-clockwise rotation of the [RF/SQ] knob will gradually reduce the RF system gain.
- As the [RF/SQ] knob is rotated counterclockwise to reduce the gain, the minimum S-meter reading will rise. This indicates that the AGC voltage being applied to the receiver is increasing (this causes a reduction in receiver gain).
 - Rotating the [RF/SQ] knob control to the fully counter-clockwise position will essentially disable the receiver, as the gain will be greatly reduced.
 - Reception frequently can be optimized by rotating the [RF/SQ] knob slightly counterclockwise to the point where the “stationary” S-meter indication is set just about the same as the incoming noise level. This will reduce the RF gain to find a level of improved signal to noise ratio.
 - The RF Gain control, along with the IPO and the Attenuator features, all affect the system receiver gain in different ways. The IPO generally should be the first feature engaged when dealing with a high noise level, or a crowded, high-level signal environment. Also, the IPO generally should be the first feature engaged, if the frequency is low enough to allow the preamplifier to be bypassed. Thereafter, the RF Gain and Attenuator features may be employed to provide precise, delicate adjustment of the receiver gain to fully optimize performance.

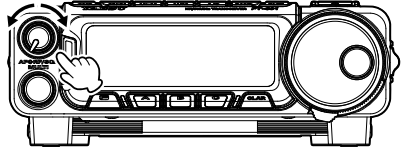

ATT (Attenuator)

The Attenuator will reduce all signals (and noise) by 12 dB, and it may be used to make reception more pleasant under extremely noisy conditions.

1. Press the [F] key repeatedly, to find the “FUNCTION-1” list screen.
2. Rotate the **MULTI** function knob to select “ATT”.
3. Press the **MULTI** function knob.
The ATT will turn on.

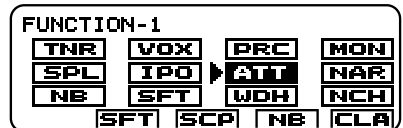
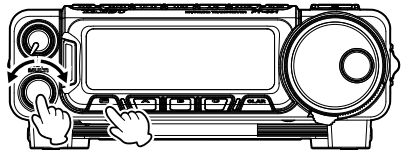

- To set the ATT to “OFF”:
 1. Press the [F] key repeatedly, to find the “FUNCTION-1” list screen.
 2. Rotate the **MULTI** function knob to select “ATT”, then press the **MULTI** function knob.
 3. Press and hold the [F] key for one second to exit the “FUNCTION-1” list screen and resume normal operation.
- The ATT function may be assigned to the [A], [B] or [C] key. Refer to “Changing the function assigned to the [A]/[B]/[C] keys” in the FT-891 Operating Manual.

Tools for Comfortable and Effective Reception

IPO (Intercept Point Optimization)

The IPO feature allows the operator to optimize the characteristics of the receiver front end according to the current noise level and the strength of incoming signals.

1. Press the [F] key repeatedly, to find the “FUNCTION-1” list screen.
2. Rotate the **MULTI** function knob to select “IPO”.
3. Press the **MULTI** function knob.

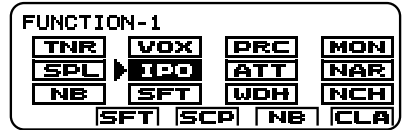
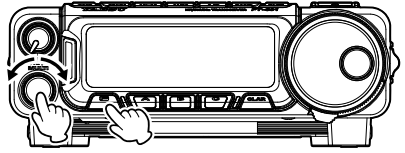

The IPO will turn on, bypassing the RF preamplifier, yielding direct feed to the first mixer.

- To set the IPO to “OFF”:

1. Press the [F] key repeatedly, to find the “FUNCTION-1” list screen.
2. Rotate the **MULTI** function knob to select “IPO”, then press the **MULTI** function knob.
3. Press and hold the [F] key for one second to exit the “FUNCTION-1” list screen and resume normal operation.

- The IPO function may be assigned to the [A], [B] or [C] key. Refer to “Changing the function assigned to the [A]/[B]/[C] keys” in the FT-891 Operating Manual.

AGC (Automatic Gain Control)

The AGC system is designed to help compensate for fading and other propagation effects. The AGC characteristics can be individually set for each operating mode. The basic objective of AGC is to maintain a constant audio output level after a certain minimum threshold signal strength is achieved.

1. Press the [F] key repeatedly, to find the “FUNCTION-2” list screen.
2. Rotate the **MULTI** function knob to select “AGC”.
3. Press the **MULTI** function knob, then rotate it to select the desired receiver-recovery time constant.

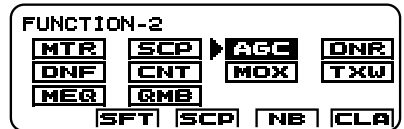
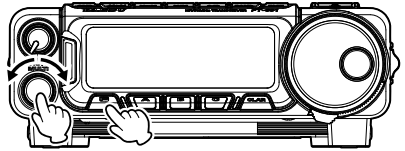

►► AUTO ►► FAST ►► MID ►► SLOW ►► ...

- Where the “AUTO” setting represents “FAST” on CW/FM/DATA-FM, “MID” on RTTY/DATA-LSB/DATA-USB, and “SLOW” on LSB/USB/AM.
- If you disable the AGC by pressing the **MULTI** function knob (“AGC” changes to “AGC”), and the S-meter (which monitors AGC voltage) will cease to function. Depending on the setting of the RF Gain control, incoming signals will probably be distorted when the AGC is turned off.
- AGC function may be assigned to the [A], [B] or [C] key. Refer to “Changing the function assigned to the [A]/[B]/[C] keys” in the FT-891 Operating Manual.

Tools for Comfortable and Effective Reception

Adjustable Receiver Audio Filter

The FT-891 includes an adjustable receiver audio filter, which provides precise, independent control of the low; and upper audio ranges.

1. Press and hold in the **[F]** key for one second to activate the Menu mode.

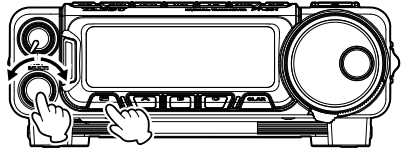

2. Rotate the **MULTI** function knob to find Menu items “06-01” through “06-04” these parameters apply to the adjustment of the receiver audio filter in the AM mode, Menu items “07-01” through “07-04” apply to the adjustment of the RX audio filter in the CW mode, Menu items “08-05” through “08-08” apply to the adjustment of the RX audio filter in the DATA mode, Menu items “10-01” through “10-04” apply to the adjustment of the RX audio filter in the RTTY mode, and Menu items “11-01” through “11-04” apply to the adjustment of the RX audio filter in the SSB mode.
3. Press the **MULTI** function knob, then rotate it to adjust the receiver audio response as desired.
4. Press the **MULTI** function knob to save the new setting.
5. Press the **[F]** key to exit the Menu mode and resume normal operation.

Mode	Menu Item	Available Values
AM	06-01 [AM LCUT FREQ]	OFF/100 - 1000 (Hz)
	06-02 [AM LCUT SLOPE]	6 / 18 (dB/oct)
	06-03 [AM HCUT FREQ]	700 - 4000 (Hz)/OFF
	06-04 [AM HCUT SLOPE]	6 / 18 (dB/oct)
CW	07-01 [CW LCUT FREQ]	OFF/100 - 1000 (Hz)
	07-02 [CW LCUT SLOPE]	6 / 18 (dB/oct)
	07-03 [CW HCUT FREQ]	700 - 4000 (Hz)/OFF
	07-04 [CW HCUT SLOPE]	6 / 18 (dB/oct)
DATA	08-05 [DATA LCUT FREQ]	OFF/100 - 1000 (Hz)
	08-06 [DATA LCUT SLOPE]	6 / 18 (dB/oct)
	08-07 [DATA HCUT FREQ]	700 - 4000 (Hz)/OFF
	08-08 [DATA HCUT SLOPE]	6 / 18 (dB/oct)
RTTY	10-01 [RTTY LCUT FREQ]	OFF/100 - 1000 (Hz)
	10-02 [RTTY LCUT SLOPE]	6 / 18 (dB/oct)
	10-03 [RTTY HCUT FREQ]	700 - 4000 (Hz)/OFF
	10-04 [RTTY HCUT SLOPE]	6 / 18 (dB/oct)
SSB	11-01 [SSB LCUT FREQ]	OFF/100 - 1000 (Hz)
	11-02 [SSB LCUT SLOPE]	6 / 18 (dB/oct)
	11-03 [SSB HCUT FREQ]	700 - 4000 (Hz)/OFF
	11-04 [SSB HCUT SLOPE]	6 / 18 (dB/oct)

Enhancing Transmit Signal Quality

Mic Gain

Adjust the microphone amplifier gain to match the microphone and your voice level.

1. Press and hold in the **[F]** key for one second to activate the Menu mode.
2. Rotate the **MULTI** function knob to select Menu Mode “**16-07**”, “**16-08**” or “**16-09**”.

16-07: SSB MIC GAIN

16-08: AM MIC GAIN

16-09: FM MIC GAIN

3. Press the **MULTI** function knob, and then rotate it to adjust the microphone gain (0 - 100).

Default: 50

4. When the adjustment is completed, press the **MULTI** function knob to save the new setting.
5. Press the **[F]** key to exit the Menu mode and resume normal operation.

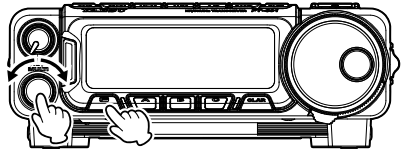

MENU	16-07	TX GNRL
SSB MIC GAIN	50	
AM MIC GAIN	50	
FM MIC GAIN	50	
DATA MIC GAIN	50	

Speech Processor (SSB Mode)

The FT-891 Speech Processor is designed to increase “talk power” by increasing the average power output (via a sophisticated compression technique) and adjusting the audio quality using the menu settings (“**15-10 [P-EQ1 FREQ]**”, “**15-13 [P-EQ2 FREQ]**”, “**15-16 [P-EQ3 FREQ]**”). The result is improved intelligibility when conditions are difficult.

1. Press the **[F]** key repeatedly, to find the “FUNCTION-1” list screen.
2. Rotate the **MULTI** function knob to select “PRC”.
3. Press the **MULTI** function knob, and then rotate it to adjust the compression level (1 - 100).

Default: 50

4. When the adjustment is completed, press the **MULTI** function knob.
5. Press and hold the **[F]** key for one second to exit the “FUNCTION-1” list screen and resume normal operation.

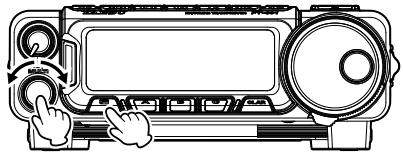

FUNCTION-1			
TNR	VOX	PRC	MON
SPI	PROC	50	JAR
NE	SFT	SCP	NE
			CLA

- To set the Speech Processor to “OFF”:
 1. Press the **[F]** key repeatedly, to find the “FUNCTION-1” list screen.
 2. Rotate the **MULTI** function knob to select “PRC”, then press the **MULTI** function knob.
 3. Press and hold the **[F]** key for one second to exit the “FUNCTION-2” list screen and resume normal operation.
- The Speech Processor function may be assigned to the **[A]**, **[B]** or **[C]** key. Refer to “Changing the function assigned to the **[A]**/**[B]**/**[C]** keys” in the FT-891 Operating Manual.

Enhancing Transmit Signal Quality

Parametric Microphone Equalizer (SSB/AM mode)

The FT-891 includes a unique Three-Band Parametric Microphone Equalizer that provides precise, independent control over the low, mid and treble ranges in the voice waveform. You may utilize one group of settings when the speech processor is off and use an alternate group of settings when the speech processor is on.

- The Parametric Equalizer is a unique technique for adjusting the signal quality. The three audio ranges may be adjusted so precisely, it is possible to craft an audio response that provides a natural and pleasant sound that you may not have ever experienced before. Alternately, the effective “talk power” can be significantly enhanced.

The configuration aspects that may be adjusted on the Parametric Equalizer are:

Center Frequency: The center frequency of each of the three bands may be adjusted.

Gain: The amount of enhancement (or suppression) within each band may be adjusted.

Q: The bandwidth over which the equalization is applied may be adjusted.

Setup of the Parametric Microphone Equalizer

- Set the RF output power to minimum value.
 - We recommend that you connect a dummy load to one of the Antenna jacks, and monitor your signal on a separate receiver, to prevent interference to other users.
 - You will have the best chance of hearing the effects of adjustments if you wear headphones (connected to the separate monitor receiver) while listening to your transmitted signal.
- To adjust the Parametric Microphone Equalizer while the speech processor is disabled, set the speech processor to “OFF” (see page 38).
 - To adjust the Parametric Microphone Equalizer while the speech processor is engaged, set the speech processor to “ON” (see page 38).
- Set the MONITOR function to “ON”, if you want to listen on the FT-891 internal monitor (see page 47).
- Press and hold in the [F] key for one second to activate the Menu mode.
- Rotate the **MULTI** function knob to find the “EQ” Menu settings containing Menu items “15-01” through “15-09”; these parameters pertain to the adjustment of the Parametric Microphone Equalizer when the speech processor is disabled. Menu items “15-10” through “15-18” pertain to the adjustment of the Parametric Microphone Equalizer when the speech processor is engaged.
- Press the **MULTI** function knob, and then rotate it to adjust a particular Menu item.
- Press and hold the PTT switch, and speak into the microphone while listening to the

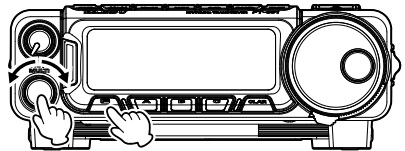

MENU	15-01	TX AUDIO
EQ1 FREQ		OFF
EQ1 LEVEL		5
EQ1 BwTH		10
EQ2 FREQ		OFF

Enhancing Transmit Signal Quality

effect of the changes you are making. Because the overall effect on the sound will change with each adjustment, make several passes through each adjustment area, to be sure that you achieve the optimum settings.

8. When all adjustments have been completed, Press the **MULTI** function knob to save the new settings.
9. Press the **[F]** key to exit the Menu mode and resume normal operation.

Activating the Parametric Microphone Equalizer

1. Adjust the Mic Gain, as described on page 38.
2. Press the **[F]** key repeatedly, to find the “FUNCTION-2” list screen.
3. Rotate the **MULTI** function knob to select “MEQ”.
4. Press the **MULTI** function knob.
The Parametric Microphone Equalizer will turn on.

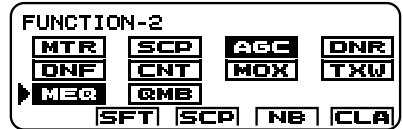
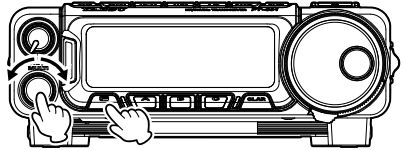

5. Press and hold the **[F]** key for one second to exit the “FUNCTION-2” list screen and resume normal operation.
- To set the Parametric Microphone Equalizer to “OFF”:
1. Press the **[F]** key repeatedly, to find the “FUNCTION-2” list screen.
 2. Rotate the **MULTI** function knob to select “MEQ”, then press the **MULTI** function knob.
 3. Press and hold the **[F]** key for one second to exit the “FUNCTION-2” list screen and resume normal operation.
- The Parametric Microphone Equalizer function may be assigned to the **[A]**, **[B]** or **[C]** key. Refer to “Changing the function assigned to the **[A]**/**[B]**/**[C]** keys” in the FT-891 Operating Manual.

3-Stage Parametric Equalizer Adjustments

	Speech Processor: “OFF”	Speech Processor: “ON”	Available Values
Center Frequency	15-01 [EQ1 FREQ]	15-10 [P-EQ1 FREQ]	OFF/100 - 700 (Hz)
	15-04 [EQ2 FREQ]	15-13 [P-EQ2 FREQ]	OFF/700 - 1500 (Hz)
	15-07 [EQ3 FREQ]	15-16 [P-EQ3 FREQ]	OFF/1500 - 3200 (Hz)
Parametric Gain	15-02 [EQ1 LEVEL]	15-11 [P-EQ1 LEVEL]	(Low) -20 - 0 - 10 (dB)
	15-05 [EQ2 LEVEL]	15-14 [P-EQ2 LEVEL]	(Mid) -20 - 0 - 10 (dB)
	15-08 [EQ3 LEVEL]	15-17 [P-EQ3 LEVEL]	(High) -20 - 0 - 10 (dB)
Q (Bandwidth)	15-03 [EQ1 BWTH]	15-12 [P-EQ1 BWTH]	(Low) 1 - 10
	15-06 [EQ2 BWTH]	15-15 [P-EQ2 BWTH]	(Mid) 1 - 10
	15-09 [EQ3 BWTH]	15-18 [P-EQ3 BWTH]	(High) 1 - 10

Enhancing Transmit Signal Quality

Adjusting the SSB Transmitted Bandwidth (SSB Mode)

For SSB transmission, a default bandwidth of 2.4 kHz is available. This bandwidth provides reasonable fidelity along with good talk power, and is the typical bandwidth used for decades for SSB transmission. The transmit bandwidth may be varied by the operator, to provide different levels of fidelity or talk power, according to individual preferences.

Here are the steps to adjust the SSB transmit bandwidth:

1. Press and hold in the **[F]** key for one second to activate the Menu mode.
2. Rotate the **MULTI** function knob to select Menu Mode “11-09 [SSB TX BPF]”.
3. Press the **MULTI** function knob, and then rotate it to select the desired bandwidth.

The available selections are: 100-3000 Hz, 100-2900 Hz, 200-2800 Hz, 300-2700 Hz, 400-2600 Hz. The default is 300-2700 Hz. A wider bandwidth will provide greater fidelity. A narrow bandwidth will compress the available transmitter power into less spectrum, resulting in more “talk power” for DX pile-ups.

4. When the selection is completed, press the **MULTI** function knob to save the new setting.
5. Press the **[F]** key to exit the Menu mode and resume normal operation.

- The higher fidelity associated with wide bandwidth will be particularly enjoyable on the low bands during local rag-chew QSOs.

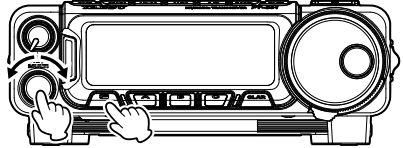

MENU	11-09	MODE SSB
SSB TX BPF	300-2700	
APF WIDTH	MEDIUM	
CONTOUR LEVEL	-15	
CONTOUR WIDTH	10	

Transmitter Convenience Features

Voice Memory (SSB/AM modes)

You may utilize the Voice Memory capability of the FT-891 to repeat recorded messages. The Voice Memory system includes five memories capable of storing up to 20 seconds of voice audio each. The maximum that any memory can hold is 20 seconds.

Voice Memory Operation

You may utilize the Voice Memory capability of the FT-891 by operating from either the Control Display, or using the optional FH-2 Remote Control Keypad, which plugs into the rear panel **REM/ALC** jack.

Recording Your Own Voice in Memory from the FT-891 Control Panel

1. Set the operating mode to SSB or AM.
2. Adjust the Mic Gain, as described on page 38.
3. Press the [F] key repeatedly, to find the "REC SETTING" list screen.

NOTE: This screen may be enabled/disabled via Menu Mode "05-11 [REC SETTING]".

4. Rotate the **MULTI** function knob to select "MEM".
5. Press the **MULTI** function knob. A blinking "REC" icon will appear in the display.
6. Rotate the **MULTI** function knob to select any numbered [CH1] through [CH5], and then press the **MULTI** function knob.
7. Press the microphone PTT switch momentarily. The "REC" icon will glow steadily and recording will begin.
8. Speak into the microphone in a normal voice level to record the message (such as "CQ DX, CQ DX, this is W 6 Delta X-Ray Charlie, W 6 Delta X-Ray Char-lie, Over"). Remember that the time limit for recording any message is 20 seconds.
9. Rotate the **MULTI** function knob to select "MEM", and then press the **MULTI** function knob.
The message storage process complete.
10. Press and hold the [F] key for one second to exit the "REC SETTING" list screen and resume normal operation.

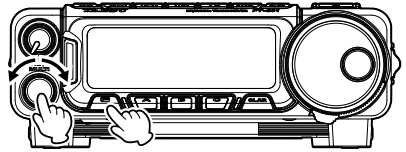

Transmitter Convenience Features

Recording Your Own Voice in Memory with the Optional FH-2

1. Set the operating mode to SSB or AM.
2. Adjust the Mic Gain, as described on page 38.
3. Press the **[MEM]** key on the FH-2. A blinking “REC” icon will appear in the display.
4. Press any of the FH-2 keys numbered [1] through [5].
5. Press the microphone PTT switch momentarily. The “REC” icon will glow steadily and recording will begin.
6. Speak into the microphone in a normal voice level to record the message (such as “CQ DX, CQ DX, this is W 6 Delta X-Ray Charlie, W 6 Delta X-Ray Char-lie, Over”). Remember that the time limit for recording any message is 20 seconds.
7. Press the **[MEM]** key on the FH-2 to complete the message storage process.

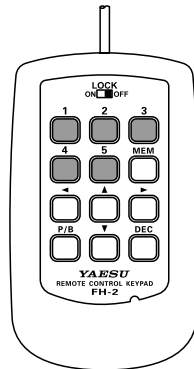
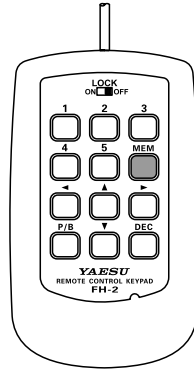

Transmitter Convenience Features

Checking Your Recording from the FT-891 Front Control Panel

1. Press the [F] key repeatedly, to find the “REC SETTING” list screen.

NOTE: This screen may be enabled/disabled via Menu Mode “05-11 [REC SETTING]”.

2. Rotate the **MULTI** function knob to select a memory [CH1] - [CH5] that was previously recorded.
 3. Press the **MULTI** function knob. The “PLAY” icon will appear in the display and you will hear the contents of the Voice Memory you just recorded.
 4. Press and hold the [F] key for one second to exit the “REC SETTING” list screen and resume normal operation.
- The playback level of the recording may be adjusted via Menu Mode “03-01 [DVS RX OUT LVL]”.

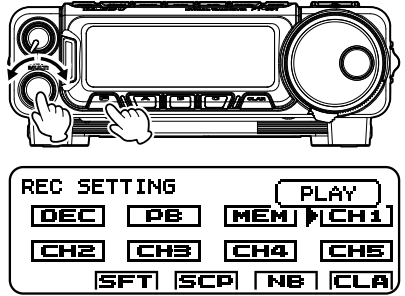

Checking Your Recording with the Optional FH-2

1. Press the FH-2 [CH1] - [CH5] key to select a previously recorded memory. The “PLAY” icon will appear in the display and you will hear the contents of the Voice Memory you just recorded.
- The playback level of the recording may be adjusted via Menu Mode “03-01 [DVS RX OUT LVL]”.

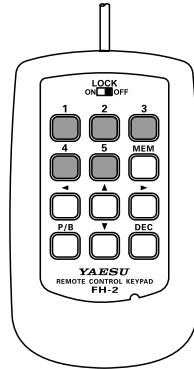

Transmitter Convenience Features

Transmitting the Recorded Message from the FT-891 Front Control Panel

1. Set the operating mode to SSB or AM.
2. Press the [F] key repeatedly, to find the "REC SETTING" list screen.

NOTE: This screen may be enabled/disabled via Menu Mode "05-11 [REC SETTING]".

3. Rotate the **MULTI** function knob to select "PB", and then press the **MULTI** function knob.
 4. Rotate the **MULTI** function knob to select any numbered [CH1] through [CH5], and then press the **MULTI** function knob. The "PLAY" icon will appear in the display and the message will be transmitted.
 5. Press and hold the [F] key for one second to exit the "REC SETTING" list screen and resume normal operation.
- The transmit (audio) level of the recording may be adjusted via Menu Mode "03-02 [DVS TX OUT LVL]".

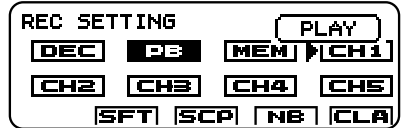
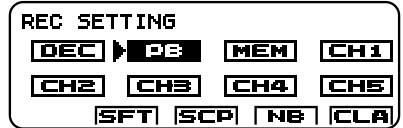
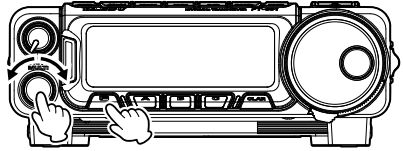

Transmitting the Recorded Message with the Optional FH-2

1. Set the operating mode to SSB or AM.
2. Press the [F] key repeatedly, to find the "REC SETTING" list screen.

NOTE: This screen may be enabled/disabled via Menu Mode "05-11 [REC SETTING]".

3. Rotate the **MULTI** function knob to select "PB", and then press the **MULTI** function knob.
 4. Press and hold the [F] key for one second to exit the "REC SETTING" list screen and resume normal operation.
 5. Press the FH-2 [CH1] - [CH5] key to select a previously recorded memory. The "PLAY" icon will appear in the display and the message will be transmitted.
- The playback level of the recording may be adjusted via Menu Mode "03-02 [DVS TX OUT LVL]".

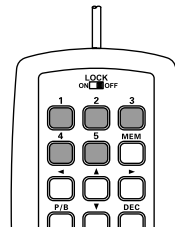
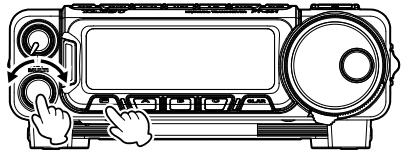

Transmitter Convenience Features

VOX (SSB/AM/FM Modes: Automatic TX/RX Switching using Voice Control)

Instead of using the microphone PTT switch or the “MOX” function to activate the transmitter, the VOX (Voice Operated Transmit) system may be used for hands-free activation of the transmitter, by the voice input to the microphone.

1. Press the **[F]** key repeatedly, to find the “FUNCTION-1” list screen.
2. Rotate the **MULTI** function knob to select “VOX”.
3. Press the **MULTI** function knob.
The VOX function will turn on.
4. Press and hold the **[F]** key for one second to exit the “FUNCTION-1” list screen and resume normal operation.

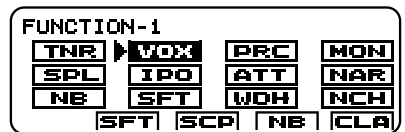
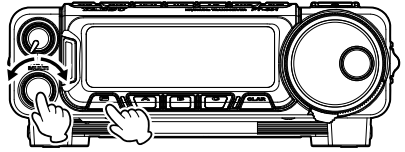

5. Without pressing the PTT switch, speak into the microphone in a normal voice level. When you start speaking, the transmitter should be activated automatically. When you finish speaking, the transceiver should return to the receive mode (after a short delay).
- To set the VOX to “OFF”:
 1. Press the **[F]** key repeatedly, to find the “FUNCTION-1” list screen.
 2. Rotate the **MULTI** function knob to select “VOX”, then press the **MULTI** function knob.
 3. Press and hold the **[F]** key for one second to exit the “FUNCTION-1” list screen and resume normal operation.
 - The VOX function may be assigned to the [A], [B] or [C] key. Refer to “Changing the function assigned to the [A]/[B]/[C] keys” in the FT-891 Operating Manual.
 - The VOX Gain may be adjusted to prevent accidental transmitter activation in a noisy environment. To adjust the VOX Gain:
 1. Press and hold in the **[F]** key for one second to activate the Menu mode.
 2. Rotate the **MULTI** function knob to select Menu Mode “**16-17 [VOX GAIN]**”, and then press the **MULTI** function knob.
 3. While speaking into the microphone, rotate the **MULTI** function knob to the point where the transmitter is quickly activated by your voice, without the back-ground noise causing the transmitter to activate.
 4. When the adjustment is satisfactory, press the **MULTI** function knob to save the setting.
 5. Press the **[F]** key to exit the Menu mode and resume normal operation.
 - The “Hang-Time” of the VOX system (the transmit/receive delay after the cessation of speech) may also be adjusted via the Menu mode. The default delay is 500 msec. To set a different delay time:
 1. Activate the VOX circuitry, if necessary.
 2. Press and hold in the **[F]** key for one second to activate the Menu mode.
 3. Rotate the **MULTI** function knob to select Menu Mode “**16-18 [VOX DELAY]**”, and then press the **MULTI** function knob.

Transmitter Convenience Features

4. Rotate the **MULTI** function knob while saying a brief syllable like “Ah” and listening to the hang time for the desired delay.
 5. When you are satisfied with the setting, press the **MULTI** function knob to save the new setting.
 6. Press the **[F]** key to exit the Menu mode and resume normal operation.
- The Anti-Trip setting adjusts the level of negative receiver audio feedback to the microphone amplifier, to prevent the receiver audio output from activating the transmitter (via the microphone). This setting can also be adjusted via Menu item “**16-19 [ANTI VOX GAIN]**”.
 - VOX operation may be engaged on either Voice modes (SSB/AM/FM) or on AFSK-based Data modes. Use Menu item “**16-16 [VOX SELECT]**” (the selections are “MIC” and “DATA”).

MONITOR (SSB/CW/AM modes)

You may listen to the quality of your transmitted signal using the Monitor feature.

1. Press the **[F]** key repeatedly, to find the “FUNCTION-1” list screen.
2. Rotate the **MULTI** function knob to select “MON”.
3. Press the **MULTI** function knob, the Monitor level pop-up screen will appear.
4. Rotate the **MULTI** function knob to set the Monitor volume level (0 - 100).

Default: 30

5. When the adjustment is completed, press the **MULTI** function knob.
 6. Press and hold the **[F]** key for one second to exit the “FUNCTION-1” list screen and resume normal operation.
- The MONITOR function may be assigned to the [A], [B] or [C] key. Refer to “Changing the function assigned to the [A]/[B]/[C] keys” in the FT-891 Operating Manual.

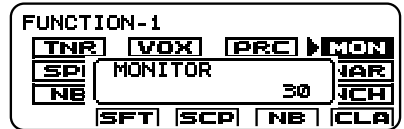
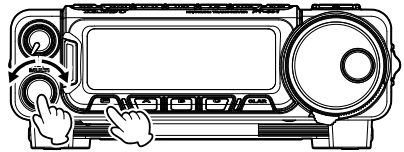

Transmitter Convenience Features

Split Operation Using the TX Clarifier

The TX Clarifier (Offset Tuning) feature may be utilized for split TX/RX operation in “casual” pile-ups, where the split is less than 10 kHz.

1. Press and hold in the [F] key for one second to activate the Menu mode.
2. Rotate the **MULTI** function knob to select Menu Mode “05-18 [CLAR SELECT]”.
3. Press the **MULTI** function knob, and then rotate it to set this Menu item to “TX” (the default setting is “RX”).
4. Press the **MULTI** function knob to save the new setting.
5. Press the [F] key to exit the Menu mode and resume normal operation.
6. Press the [CLAR] key.

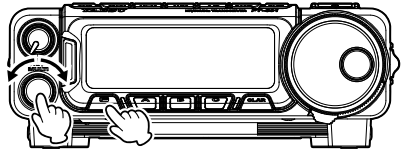

MENU	05-18	GENERAL
CLAR SELECT	TX	
APD	OFF	
FAN CONTROL	NORMAL	
AM LCUT FREQ	OFF	

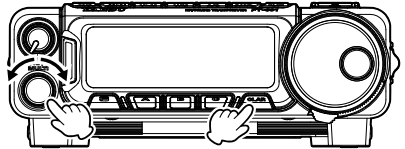

- The Clarifier is usually used for receiver offset tuning. However, for DX pile-ups where the DX station is using a split of less than 10 kHz, the TX Clarifier function is also the quickest way to set the transmitter to the desired offset frequency.
7. Rotate the **MULTI** function knob to set the desired transmitter offset. A maximum split of ± 9.998 kHz may be set.
 8. To exit from TX Clarifier operation, press the [CLAR] key once more.

Transmitter Convenience Features

Split-Frequency Operation

A powerful capability of the FT-891 is its flexibility in Split Frequency operation using the VFO-A and VFO-B frequency registers. This makes the FT-891 especially useful for high-level DX-peditions. The Split operation capability is very clever and easy to use.

1. Rotate the **DIAL** knob to set the desired RX frequency to VFO-A.
2. Press the **[A/B]** key, then rotate the **DIAL** knob to set the desired split TX frequency to VFO-B.
3. Press the **[A/B]** key.
4. Press the **[F]** key repeatedly, to find the “FUNCTION-1” list screen.
5. Rotate the **MULTI** function knob to select “SPL”.
6. Press the **MULTI** function knob.
7. Press and hold the **[F]** key for one second to exit the “FUNCTION-1” list screen and resume normal operation.
8. During Split operation, the VFO-A register will be used for reception, while the VFO-B register will be used for transmission.

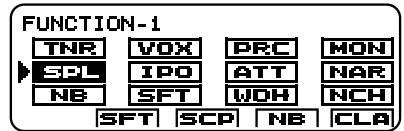
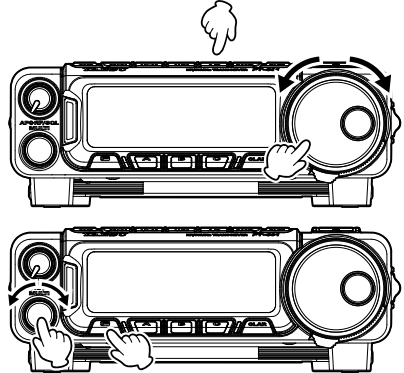

- During Split operation, pressing the **[A/B]** key will reverse the contents of VFO-A and VFO-B. Press the **[A/B]** key once more to return to the original frequency alignment.
- During Split operation you may listen to the TX frequency temporarily.
 1. Press the **[F]** key repeatedly, to find the “FUNCTION-2” list screen.
 2. Rotate the **MULTI** function knob to select “TXW”.
 3. The transmit frequency on VFO-B may be changed while pressing the **MULTI** function knob during split operations.
 - TXW function may be assigned to the [A], [B] or [C] key. Refer to “Changing the function assigned to the [A]/[B]/[C] keys” in the FT-891 Operating Manual.
- During Split operation it is also possible to set VFO-A and VFO-B to different Amateur bands if a multi band antenna is used.
- SPL function may be assigned to the [A], [B] or [C] key. Refer to “Changing the function assigned to the [A]/[B]/[C] keys” in the FT-891 Operating Manual.

Transmitter Convenience Features

Quick Split Operation

The Quick Split feature allows setting a one-touch offset of +5 kHz compared to the VFO-A frequency, to be applied to the transceiver VFO-B (transmit) frequency.

1. Start with regular transceiver operation on the VFO-A.
2. Press the [F] key repeatedly, to find the "FUNCTION-1" list screen.
3. Rotate the **MULTI** function knob to select "SPL".
4. Press and hold the **MULTI** function knob for one second to engage the Quick Split feature, and apply a frequency 5 kHz above the VFO-A frequency to the VFO-B frequency register.

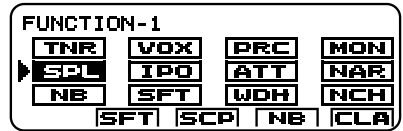
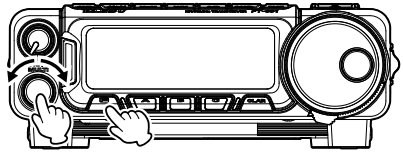

5. Press and hold the **MULTI** function knob for one second to increment the Sub (VFO-B) offset frequency another +5 kHz.
- SPL function may be assigned to the [A], [B] or [C] key. Refer to "Changing the function assigned to the [A]/[B]/[C] keys" in the FT-891 Operating Manual.
 - The offset of VFO-B from VFO-A is programmed via the Menu and is set to +5 kHz at the factory. However, other offsets may be selected using the following procedure:
 1. Press and hold in the [F] key for one second to activate the Menu mode.
 2. Rotate the **MULTI** function knob to select Menu Mode "05-13 [QUICK SPL FREQ]".
 3. Press the **MULTI** function knob, and then rotate it to select the desired offset. The available setting range is -20kHz - +20kHz (factory default: +5 kHz).
 4. Press the **MULTI** function knob to save the new setting.
 5. Press the [F] key to exit the Menu mode and resume normal operation.

Memory Operation

Checking a Memory Channel Status

Before programming a channel into memory, you can check the current contents of that channel without the danger of over-writing the channel accidentally.

1. Press the [M▶V] or [V▶M] key to display the “MEMORY CHANNEL” list screen.
The data stored in the currently selected memory channel will be displayed on the LCD. However, since you are only checking the contents of the memory channel, the radio will not have moved to the memory channel frequency.
2. Rotate the **MULTI** function knob to select a different memory channel.
3. To exit from the Memory Check mode and return to the VFO-A mode, press the [A] (**BCK**) key.

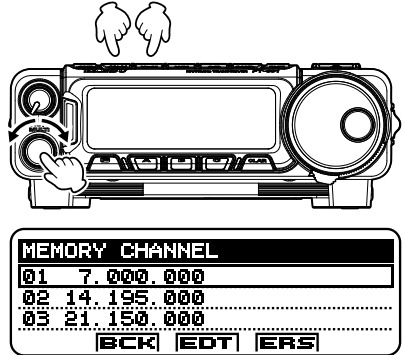

- While operating in the VFO mode, using Memory Check, you may store the current VFO frequency into the selected memory by press the [V▶M] key.

Memory Tune (MT) operation

The frequency may be freely tuned off from any memory channel in “Memory Tune” mode; this is similar to VFO operation.

So long as you do not over-write the contents of the current memory, Memory Tune operation will not alter the contents of the memory channel.

1. While operating in the VFO mode, press the [V/M] key to enter the Memory mode.
2. Rotate the **MULTI** function knob to select the memory channel.
3. Rotate the **DIAL** knob; you will now observe that the memory channel frequency is changing. The “Memory Channel Number” will be replaced by one which indicates “MT” (Memory Tune).

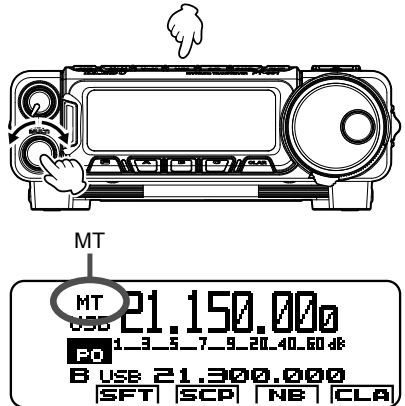

- During Memory Tune operation, you may change operating modes, and engage the offset Clarifier, if desired.

4. Press the [V/M] key momentarily to return to the originally memorized frequency of the current memory channel. One more press of the [V/M] key will return to VFO operation.

Memory Operation

Labeling Memories

An Alphanumeric “Tag” (label) may be appended to each memory channel to aid in recollection of the channel’s use (such as a club name, etc.). To do this:

1. Press the **[M▶V]** or **[V▶M]** key to display the “MEMORY CHANNEL” list screen.
2. Rotate the **MULTI** function knob to recall the memory channel that you wish to append a label.
3. Press the **[B](EDT)** key to display the “MEMORY CHANNEL EDIT” screen.
4. Rotate the **MULTI** function knob to select the letters, numbers, or symbols of the desired label.
5. Press the **MULTI** function knob to move to the next character.
6. Press the **MULTI** function knob, then rotate it to select the next letters, numbers, or symbols.
7. Repeat steps 5 through 6 to program the remaining letters, numbers, or symbols of the desired label. 12 characters may be used in the creation of a label.
8. When the label is completed, press the **[C](ENT)** key to exit the “MEMORY CHANNEL EDIT” screen.
9. To exit from the “MEMORY CHANNEL” list screen and return to the VFO-A mode, press the **[A](BCK)** key.

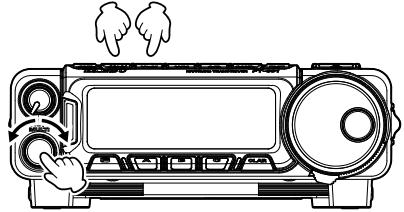

Displaying the memory tag

The frequency and name tag display format can be selected for desired channel.

1. Press the **[M▶V]** or **[V▶M]** key to display the “MEMORY CHANNEL” list screen.
2. Rotate the **MULTI** function knob to recall the desired memory channel.
3. Press the **[B](EDT)** key to display the “MEMORY CHANNEL EDIT” screen.
4. Press the **[B](TAG)** key to activate the Alpha-Numeric Tag. Repeatedly pressing this key will toggle operation between “Frequency” display and “Tag” display.
5. Press the **[A](BCK)** key to exit the “MEMORY CHANNEL EDIT” screen.
6. To exit from the “MEMORY CHANNEL” list screen and return to the VFO-A mode, press the **[A](BCK)** key.

Memory Operation

Memory Groups

Memory channels may be arranged into as many as six convenient groups, for easy identification and selection. For example, different memory groups may be designated for AM BC stations, short-wave broadcast stations, contest frequencies, repeater frequencies, PMS limits, or any other groupings you might like.

Each memory group is capable of holding up to 20 memory channels (except Memory Group 1 is fixed to 19 memory channels).

Memory Group Assignment

1. Press and hold in the [F] key for one second to activate the Menu mode.
2. Rotate the **MULTI** function knob to select Menu Mode “05-09 [MEM GROUP]”.
3. Press the **MULTI** function knob, and then rotate it to set this Menu item to “ENABLE” (the default setting is “DISABLE”).
4. Press the **MULTI** function knob to save the new setting.
5. Press the [F] key to exit. Operation will now be restricted to the six Memory Groups.

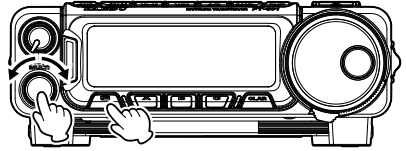

MENU	05-09	GENERAL
MEM GROUP		ENABLE
FM SETTING		DISABLE
REC SETTING		DISABLE
ATAS SETTING		DISABLE

- To cancel Memory Group operation, repeat steps 1 through 5 above, choosing “DISABLE” in step 3.
- To avoid confusion, note that the PMS memory group and the PMS memories “P1L” through “P9U” will be so designated.

Group Number	Memory Channel Number
GROUP 1	01 - 19
GROUP 2	20 - 39
GROUP 3	40 - 59
GROUP 4	60 - 79
GROUP 5	80 - 99
GROUP 6	P1L/P1U - P9L/P9U
GROUP 7*	501 - 510 (501 - 507**)

*: USA and UK version only. **: UK Version.

Memory Operation

Choosing the Desired Memory Group

If desired, just the memories within a particular Memory Group may be recalled.

1. Press the **[M▶V]** or **[V▶M]** key to display the “MEMORY CHANNEL” list screen.
 2. Press the **[A](GRP)** key, then rotate it to select the desired memory group.
 3. Press the **MULTI** function knob to exit the “MEMORY CHANNEL” list screen and return to the Memory mode.
 4. Rotate the **MULTI** function knob to select the desired Memory Channel within the Selected Memory Group.
- If no channels have been assigned to a particular Memory Group, that Group cannot be accessed.

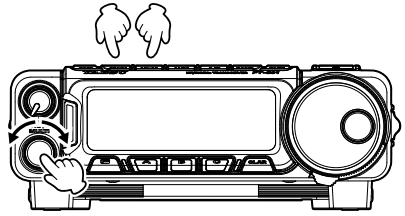

MEMORY CHANNEL	GROUP 1
01	7.000.000
02	14.195.000
03	21.150.000

[GRP] [EDT] [ERS]

Operation on Alaska Emergency Frequency: 5167.5 kHz (U.S. Version Only)

Section 97.401(d) of the regulations governing amateur radio in the United States permit emergency amateur communications on the spot frequency of 5167.5 kHz by stations in (or within 92.6 km of) the state of Alaska. This frequency is only to be used when the immediate safety of human life and/or property are threatened, and is never to be used for routine communications.

The FT-891 includes the capability for transmission and reception on 5167.5 kHz under such emergency conditions via the Menu system. To activate this feature:

1. Press and hold in the [F] key for one second to activate the Menu mode.
2. Rotate the **MULTI** function knob to select Menu Mode “16-23 [EMERGENCY FREQ]”.
3. Press the **MULTI** function knob, and then rotate it to set this Menu item to “ENABLE” (the default setting is “DISABLE”).
4. Press the **MULTI** function knob to save the new setting.
5. Press the [F] key to exit the Menu mode and resume normal operation.

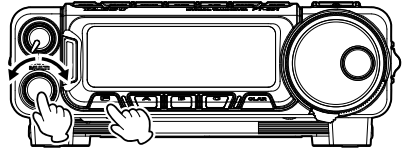

MENU	16-23	TX GNRL
EMERGENCY FREQ	ENABLE	
RESET	FACTORY	
MAIN VERSION	Vxx-xx	
DSP VERSION	Vxx-xx	

Emergency communication on this spot frequency is now possible.

6. While operating in the VFO mode, press the [V/M] key to enter the Memory mode.
7. Rotate the **MULTI** function knob to select the emergency channel (“EMG”), which is found between channels “510” and “M01”).

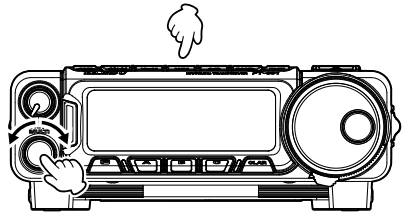

- If you wish to disable operation capability on the Alaska Emergency Frequency, repeat the above procedures, but set the Menu Mode “16-23 [EMERGENCY FREQ]” to “DISABLE” in step 3.
- In an emergency, note that a half-wave dipole cut for this frequency should be approximately 45’3” on each leg (90’6” total length). Emergency operation on 5167.5 kHz is shared with the Alaska-Fixed Service. This transceiver is not authorized for operation, under the FCC Part 87, for aeronautical communications.

Scanning Operation

Scan Resume Options

The manner in which the scanner resumes after it has paused on a signal may be selected by using Menu Mode “**05-16 [MIC SCAN RESUME]**”. The default “TIME” (5 sec) setting will cause the scanner to resume scanning after five seconds; however the scan setting may be changed to resume only after the received signal has dropped out.

To choose the Scan-Resume mode:

1. Press and hold in the [F] key for one second to activate the Menu mode.
2. Rotate the **MULTI** function knob to select Menu Mode “**05-16 [MIC SCAN RESUME]**”.
3. Press the **MULTI** function knob, and then rotate it to select the desired Scan-Resume mode.

PAUSE: During automatic scanning, the scanner will hold until the signal disappears.

TIME: If the signal does not disappear within five seconds, the scanner will resume scanning for the next active channel (frequency). If there is no signal, the scanner continues scanning automatically.

4. Press the **MULTI** function knob to save the new setting.
5. Press the [F] key to exit the Menu mode and resume normal operation.

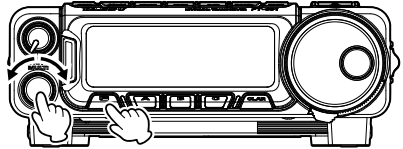

MENU	05-16	GENERAL
MIC SCAN RESUME TIME		
REF FREQ ADJ	0	
CLAR SELECT	Rx	
APO		OFF

Scanning Operation

PMS (Programmable Memory Scanning)

To limit scanning (and manual tuning) within a particular frequency range, the Programmable Memory Scanning (PMS) feature utilizes nine special-purpose memory pairs (“P1L/P1U” through “P9L/P9U”). The PMS feature is especially useful in helping you to observe any operating sub-band limits, which apply to your Amateur license class.

1. Store the Lower and Upper tuning/scanning limit frequencies into the memory pair “P1L” and “P1U”, respectively, or any other “L/U” pair of memories in the special PMS memory register.
2. Press the [V/M] key to enter the “Memory” mode.
3. Rotate the **MULTI** function knob to select memory channel “P1L” or “P1U”.
4. Turn the **DIAL** knob slightly (to activate memory tuning). Tuning and scanning are now limited to the range within the P1L/P1U limits until the [V/M] key is pressed again to return to the memory channel.

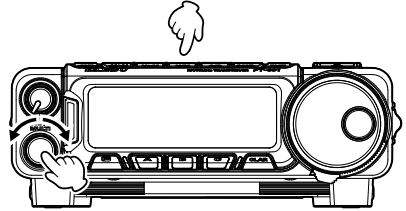

Memory Channel

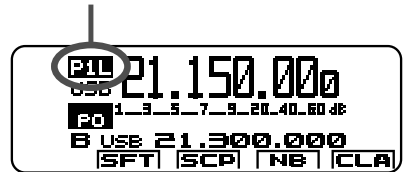

5. Press and hold in the microphone [UP] or [DWN] key for one second to start scanning in the specified direction.
 6. To cancel scanning, press the [V/M] key.
 7. One more press of the [V/M] key momentarily to display the “MEMORY CHANNEL” list screen.
- If the scanner halts on an incoming signal, the decimal point between the “MHz” and “kHz” digits of the frequency display will blink.
 - If the incoming signal disappears, scanning will resume in about five seconds.
 - On the SSB/CW and SSB-based Data modes, the scanner will pause on a received signal, then will step across the signal very slowly, giving you time to stop the scan, if you like. However, in these modes on the VFO, the scanner does not stop.
 - If the scan has paused on a signal, pressing the microphone [UP] or [DWN] key will cause scanning to resume instantly.
 - If the **DIAL** knob is rotated while scanning is in progress, the scanning will continue up or down in frequency according to the direction of the **DIAL** Knob rotation. (in other words, if the dial is rotated to the left when scanning toward a higher frequency, the direction of the scan will reverse.)
 - If the microphone PTT button is pressed during scanning, the scanner will halt at once. Pressing the PTT button during scanning will not cause transmission.

Miscellaneous Setting

Beep Level

The beep sound volume level may also be adjusted.

1. Press and hold in the [F] key for one second to activate the Menu mode.
2. Rotate the **MULTI** function knob to select Menu Mode “05-04 [BEEP LEVEL]”.
3. Press the **MULTI** function knob, and then rotate it to adjust the beep sound volume level (0 - 100).

Default: 30

4. Press the **MULTI** function knob to save the new setting.
5. Press the [F] key to exit the Menu mode and resume normal operation.

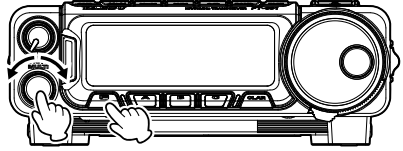

MENU	05-04	GENERAL
BEEP LEVEL	50	
RF/SQL VR	RF	
CAT RATE	4500bps	
CAT TOT	10msec	

TOT (Time-Out Timer)

The “Time-Out Timer” (TOT) shuts off the transmitter after continuously transmitting for the programmed time.

1. Press and hold in the [F] key for one second to activate the Menu mode.
2. Rotate the **MULTI** function knob to select Menu Mode “05-14 [TX TOT]”.
3. Press the **MULTI** function knob, and then rotate it to select the TOT countdown time (OFF/1 - 30 min).

Default: OFF (10 min: European Version.)

4. Press the **MULTI** function knob to save the new setting.
5. Press the [F] key to exit the Menu mode and resume normal operation.

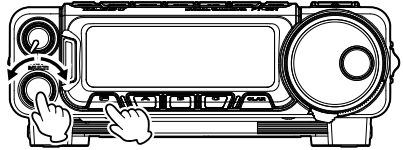

MENU	05-14	GENERAL
TX TOT	OFF	
MIC SCAN	ENABLE	
MIC SCAN RESUME TIME		
REF FREQ ADJ	0	

Miscellaneous Setting

APO (Automatic Power Off)

The APO feature helps conserve battery life by automatically turning the transceiver off after a user-defined period of time within which there has been no dial or key activity.

1. Press and hold in the [F] key for one second to activate the Menu mode.
2. Rotate the **MULTI** function knob to select Menu Mode “05-19 [APO]”.
3. Press the **MULTI** function knob, and then rotate it to select the desired time period after which the radio will automatically shut down (OFF/1/2/4/6/8/10/12 h).

Default: OFF

4. Press the **MULTI** function knob to save the new setting.
5. Press the [F] key to exit the Menu mode and resume normal operation.

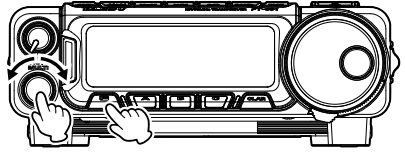

MENU	05-19	GENERAL
APO		OFF
FAN CONTROL		NORMAL
AM LCUT FREQ		OFF
AM LCUT SLOPE		6dB/oct

FAN Control

The cooling fan can be set to operate for two different temperature conditions.

1. Press and hold in the [F] key for one second to activate the Menu mode.
2. Rotate the **MULTI** function knob to select Menu Mode “05-20 [FAN CONTROL]”.
3. Press the **MULTI** function knob, and then rotate it to select the desired condition.

NORMAL: The cooling fan operates *only* when the temperature becomes high.

CONTEST: The cooling fan starts to operate as the temperature begins to rise.

Default: NORMAL

4. Press the **MULTI** function knob to save the new setting.
5. Press the [F] key to exit the Menu mode and resume normal operation.

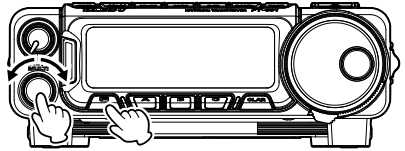

MENU	05-20	GENERAL
FAN CONTROL		NORMAL
AM LCUT FREQ		OFF
AM LCUT SLOPE		6dB/oct
AM HCUT FREQ		OFF

Miscellaneous Setting

Meter Peak Hold

Sets the time duration the maximum value reading is shown on the meter (peak hold).

1. Press and hold in the [F] key for one second to activate the Menu mode.
2. Rotate the **MULTI** function knob to select Menu Mode “02-05 [PEAK HOLD]”.
3. Press the **MULTI** function knob, and then rotate it to select the meter peak hold time (OFF/0.5/1.0/2.0 seconds).

Default: OFF

4. Press the **MULTI** function knob to save the new setting.
5. Press the [F] key to exit the Menu mode and resume normal operation.

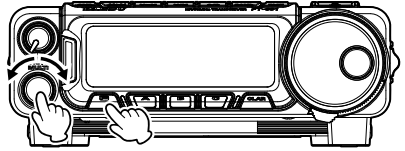

MENU	02-05	DISPLAY
PEAK HOLD		OFF
ZIN LED		DISABLE
POP-UP MENU		LOWER
DVS RX OUT LVL		50

POP-UP Menu

Set the position (Lower or Upper) of the pop-up window on the display screen.

1. Press and hold in the [F] key for one second to activate the Menu mode.
2. Rotate the **MULTI** function knob to select Menu Mode “02-07 [POP-UP MENU]”.
3. Press the **MULTI** function knob, and then rotate it to set the display position (Lower or Upper) of the pop-up window.
4. Press the **MULTI** function knob to save the new setting.
5. Press the [F] key to exit the Menu mode and resume normal operation.

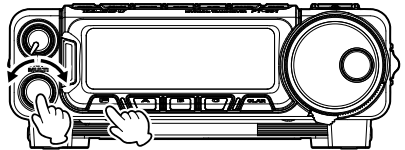

MENU	02-07	DISPLAY
POP-UP MENU		LOWER
DVS RX OUT LVL		50
DVS TX OUT LVL		50
KEYER TYPE		ELEKEY-B

Miscellaneous Setting

Key Lamp Dimmer

The Key lamp illumination level may also be adjusted.

1. Press and hold in the [F] key for one second to activate the Menu mode.
2. Rotate the **MULTI** function knob to select Menu Mode “02-02 [DIMMER BACKLIT]”.
3. Press the **MULTI** function knob, and then rotate it to adjust the Key lamp illumination for a comfortable brightness level. The change may be observed as the knob is adjusted (1 - 15).

Default: 8

4. Press the **MULTI** function knob to save the new setting.
5. Press the [F] key to exit the Menu mode and resume normal operation.

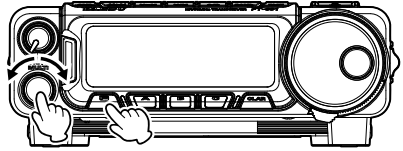

MENU	02-02	DISPLAY
DIMMER BACKLIT	8	
DIMMER LCD	8	
DIMMER TX/BUSY	8	
PEAK HOLD	OFF	

TX/BUSY Indicator Dimmer

The TX/BUSY indicator illumination level may also be adjusted using the Menu Mode.

1. Press and hold in the [F] key for one second to activate the Menu mode.
2. Rotate the **MULTI** function knob to select Menu Mode “02-04 [DIMMER TX/BUSY]”.
3. Press the **MULTI** function knob, and then rotate it to adjust the TX/BUSY indicator illumination for a comfortable brightness level. The change may be observed as the knob is adjusted (1 - 15).

Default: 8

4. Press the **MULTI** function knob to save the new setting.
5. Press the [F] key to exit the Menu mode and resume normal operation.

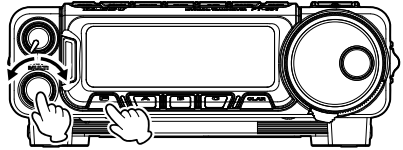

MENU	02-04	DISPLAY
DIMMER TX/BUSY	8	
PEAK HOLD	OFF	
ZIN LED	DISABLE	
POP-UP MENU	LOWER	

RTTY (Radio Teletype) Operation

Example of Connecting RTTY Communications device

Connecting to the TU (Terminal Unit)

Connect the RTTY communications TU (Terminal Unit) to the rear panel RTTY/DATA terminal. Be sure to read the instruction manual of the TU device before connecting it.

- Adjust the RTTY data output level using Menu Mode “10-08 [RTTY OUT LEVEL]”.

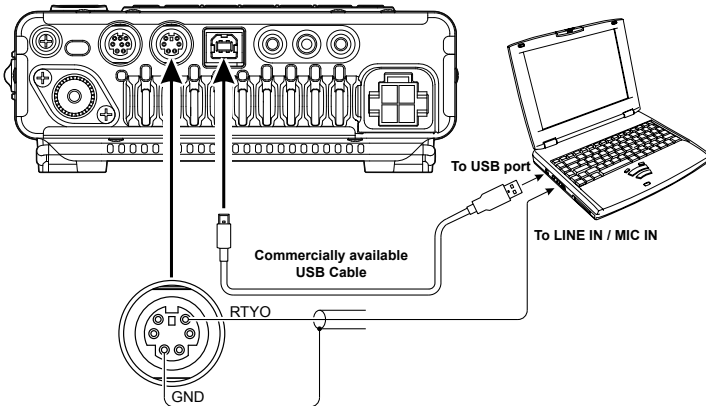
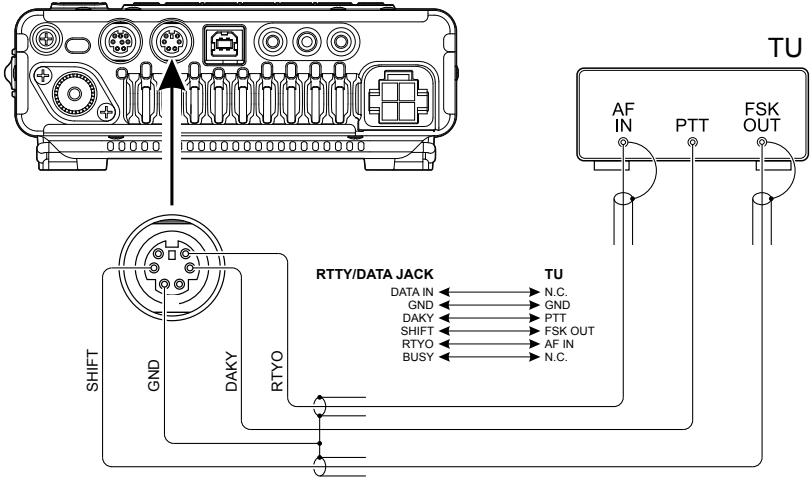

RTTY (Radio Teletype) Operation

Connecting to your Computer

- Install the RTTY application software and driver on your computer in advance.
- RTTY communication application (YAESU does not provide technical support for the use or operation of the application.)
- Virtual COM port driver (Visit the Yaesu website “<http://www.yaesu.com/>” to download the designated driver and Installation Manual.)

1. Use a commercially available USB cable to connect the USB jack on the rear panel of the FT-891 and the computer.
2. Press and hold the **[BAND(MODE)]** key for one second.

The “MODE SELECT” screen will appear in the display.

3. Rotate the **DIAL** knob to select the “RTTY” mode.
4. Press and hold in the **[F]** key for one second to activate the Menu mode.

5. Rotate the **MULTI** function knob to select Menu Mode “07-12 [PC KEYING]”.
6. Press the **MULTI** function knob, and then rotate it to set this Menu item to “RTS” or “DTR”.

7. Press the **MULTI** function knob to save the new setting.
8. Press the **[F]** key to exit the Menu mode and resume normal operation.

- “RTS” and “DTR” will be set as shown below.

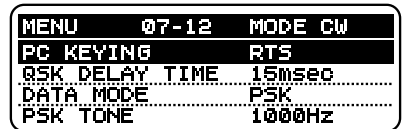
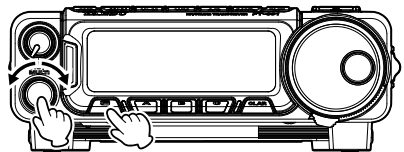
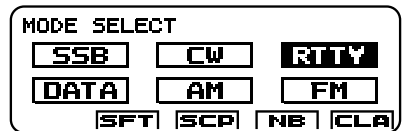
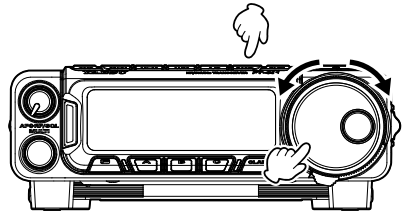

		RTTY-PTT	RTTY-SHIFT
Menu item “07-12 [PC KEYING]”	RTS	RTS	DTR
	DTR	DTR	RTS

9. RTTY-PTT and RTTY-SHIFT operations can be set from the Standard-COM port of the virtual COM port. On the computer, open Device Manager from the Control Panel to check the COM port number and set each item of the RTTY communication application.

DATA (PSK) Operation

Example of DATA Communications device

Use commercial or free computer software for PSK data communications. See the illustration below for connecting the FT-891 transceiver to a computer. Be sure to read the instruction manual of the interface device to be connected to the radio and computer.

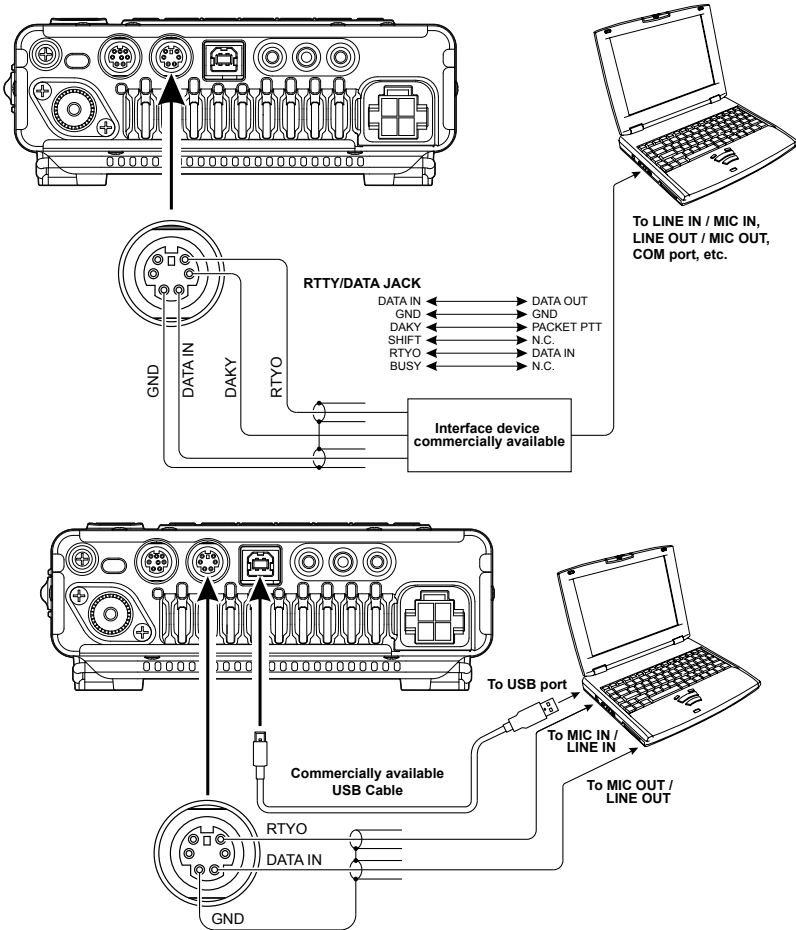

- The FT-891 allows for PSK, Olivia, Contestia, etc. digital modes to be sent by the Data method or SSB. The conventional method is to use USB, except RTTY, however the Data method allows for more accurate carrier frequency control, which is helpful in a Contest or DX environment.

DATA (PSK) Operation

DATA-AFSK (PSK, OLIVIA, CONTESTIA, RTTY etc.)

FT-891 Settings

1. Press and hold in the [F] key for one second to activate the Menu mode.
2. Rotate the **MULTI** function knob to select Menu Mode “11-07 [SSB BFO]”.
3. Press the **MULTI** function knob, and then rotate it to set this Menu item to “USB”.
4. Press the **MULTI** function knob to save the new setting.
5. Press the [F] key to exit the Menu mode and resume normal operation.

- USB is the conventional mode for AFSK transmission on all bands, however some users may be using LSB.

6. Press and hold the [BAND(MODE)] key for one second.
The “MODE SELECT” screen will appear in the display.
7. Rotate the **DIAL** knob to select the “SSB” mode.
8. Press and hold in the [F] key for one second to activate the Menu mode.
9. Rotate the **MULTI** function knob to select Menu Mode “11-08 [SSB PTT SELECT]”.
10. Press the **MULTI** function knob, and then rotate it to set this Menu item to “RTS”.
11. Press the **MULTI** function knob to save the new setting.
12. Press the [F] key to exit the Menu mode and resume normal operation.

- All other SSB and DATA settings remain at their default.

Connect a USB Cable from the FT-891 USB port and your computer

- Before connecting the USB cable you must download the Virtual COM port driver. The Drivers can be found on the FT-891 FILES page at the Yaesu Web page, “<http://www.yaesu.com/>”. Once the Drivers have been installed connect the USB cable to the computer and then to the radio. At your computer’s Device Manager you will find a Standard Driver and Enhanced Driver installed.

Computer Settings

COM PORT

Check the Com Port assignments in the Computer Device Manager to be sure the Enhanced and Standard Drivers are installed. Make a note of the Com Port numbers assigned.

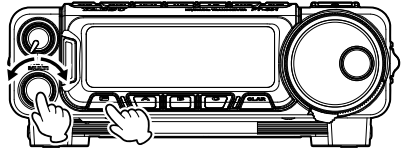

MENU	11-07	MODE SSB
SSB BFO		USB
SSB PTT SELECT		DATA
SSB TX BPF		300-2700
APF WIDTH		MEDIUM

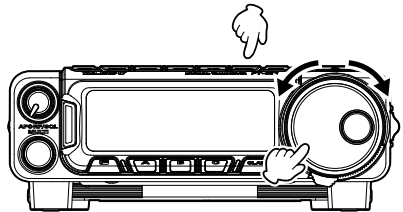

MODE SELECT		
SSB	CW	RTTY
DATA	AM	FM
SFT	SCP	NE CLA

MENU	11-08	MODE SSB
SSB PTT SELECT		RTS
SSB TX BPF		300-2700
APF WIDTH		MEDIUM
CONTOUR LEVEL		-15

DATA (PSK) Operation

Software Settings

- There are many good Data Mode Operating Software programs available on the internet. Each of these programs will have their own Setup instructions. The following general information is common to most software application setup:

COM PORT Settings

To start set the Com Port setting to the Enhanced Driver. If there is a problem switch to the Standard Driver.

PTT Settings

Set the PTT to RTS on DTR off.

Soundcard

At the software Soundcard Volume setting, increase the volume to about 70% to start.

- If the soundcard volume setting is too low, the radio will not switch to Transmit.

DATA (PSK) Operation

DATA MODE (PSK, OLIVIA, CONTESTIA, RTTY etc.)

FT-891 Settings

1. Press and hold in the [F] key for one second to activate the Menu mode.
2. Rotate the **MULTI** function knob to select Menu Mode “08-12 [DATA BFO]”.
3. Press the **MULTI** function knob, and then rotate it to set this Menu item to “USB”.
 - USB is the conventional mode for Digital (not RTTY) transmission on all bands, however some users may be using LSB.
4. Press and hold the [BAND(MODE)] key for one second.

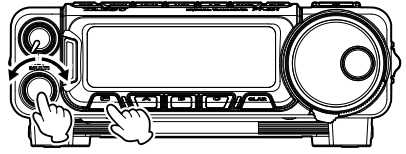

MENU	08-12	MODE DAT
DATA BFO		USB
FM MIC SELECT		MIC
FM OUT LEVEL		50
PKT PTT SELECT		DAKY

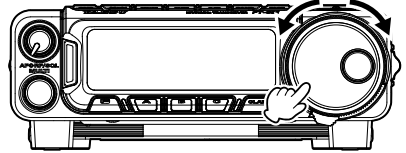

- The “MODE SELECT” screen will appear in the display.
5. Rotate the **DIAL** knob to select the “DATA” mode.
 6. Press and hold in the [F] key for one second to activate the Menu mode.
 7. Rotate the **MULTI** function knob to find Menu Mode “08-01”, “08-02”, “08-09” or “08-10”.
 8. Press the **MULTI** function knob, and then rotate it to set these Menu item as shown below.

MODE SELECT		
SSB	CW	RTTY
DATA	AM	FM
SFT	SCP	NE CLA

Menu Function	Setting
08-01 [DATA MODE]	PSK
08-02 [PSK TONE]	Adjust for desired center frequency.
08-09 [DATA IN SELECT]	MIC
08-10 [DATA PTT SELECT]	RST

9. Press the **MULTI** function knob to save the new settings.
10. Press the [F] key to exit the Menu mode and resume normal operation.

All other SSB and DATA settings remain at their default.

Connect a USB Cable from the FT-891 USB port to the computer

Before connecting the USB cable, you must download the Virtual COM port driver. The Drivers can be found on the FT-891 FILES page at the Yaesu Web page, “<http://www.yaesu.com/>”. Once the Drivers have been installed, connect the USB cable to the computer and then to the radio. In the computer Device Manager you will find the Standard Driver and the Enhanced Driver installed.

DATA (PSK) Operation

Computer Settings

COM PORT

Check the Com Port assignments on the computer Device Manager to be sure the Enhanced and Standard Drivers are installed . Make a note of the Com Port numbers assigned.

Software Settings

- There are many good Data Mode Operating Software programs available on the internet. Each of these programs will have their own Setup instructions. The following general information is common to most software application setup:

COM PORT Settings

To start set the Com Port setting to the Enhanced Driver. If there is a problem switch to the Standard Driver.

PTT Settings

Set the PTT to RTS on DTR off.

Soundcard

At the software Soundcard Volume setting increase the volume to about 70% to start.

- If the soundcard volume setting is too low, the radio will not switch to Transmit.

Menu Mode

The FT-891 Menu mode, already described in parts of many previous chapters, is easy to activate and setup. The Menus may be used to configure many of transceiver parameters, some of which have not been detailed previously. Use the following procedure to activate the Menu mode:

1. Press and hold in the **[F]** key for one second to activate the Menu mode.
2. Rotate the **MULTI** function knob to select the Menu Item to be adjusted.
3. Press the **MULTI** function knob, and then rotate it to adjust the selected Menu item.
4. When the adjustment is satisfactory, press the **MULTI** function knob to save the new settings.
5. Press the **[F]** key to exit the Menu mode and resume normal operation.

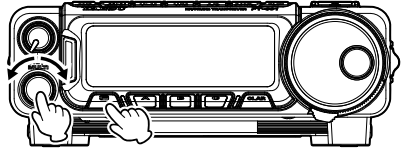

MENU	01-01	AGC
AGC FAST DELAY		300msec
AGC MID DELAY		700msec
AGC SLOW DELAY		3000msec
LCD CONTRAST		8

Menu / Item		Available Values	Default
AGC			
	01-01	AGC FAST DELAY	20 - 4000 (msec)
	01-02	AGC MID DELAY	20 - 4000 (msec)
	01-03	AGC SLOW DELAY	20 - 4000 (msec)
			300msec
			700msec
			3000msec
DISPLAY			
	02-01	LCD CONTRAST	1 - 15
	02-02	DIMMER BACKLIT	1 - 15
	02-03	DIMMER LCD	1 - 15
	02-04	DIMMER TX/BUSY	1 - 15
	02-05	PEAK HOLD	OFF/0.5/1.0/2.0 (sec)
	02-06	ZIN LED	ENABLE/DISABLE
	02-07	POP-UP MENU	UPPER/LOWER
			8
			8
			8
			8
			OFF
			DISABLE
			LOWER
DVS			
	03-01	DVS RX OUT LVL	0 - 100
	03-02	DVS TX OUT LVL	0 - 100
			50
			50
KEYER			
	04-01	KEYER TYPE	OFF/BUG/ELEKEY-A/ELEKEY-B/ ELEKEY-Y/ACS
	04-02	KEYER DOT/DASH	NOR/REV
	04-03	CW WEIGHT	2.5 - 4.5
	04-04	BEACON INTERVAL	OFF/1 - 240 (sec) (1 sec/step) 270 - 690 (sec) (30 sec/step)
	04-05	NUMBER STYLE	1290/AUNO/AUNT/A2NO/ A2NT/12NO/12NT
	04-06	CONTEST NUMBER	0 - 9999
	04-07	CW MEMORY 1	TEXT/MESSAGE
	04-08	CW MEMORY 2	TEXT/MESSAGE
	04-09	CW MEMORY 3	TEXT/MESSAGE
	04-10	CW MEMORY 4	TEXT/MESSAGE
	04-11	CW MEMORY 5	TEXT/MESSAGE
			ELEKEY-B
			NOR
			3.0
			OFF
			1290
			1
			TEXT
			TEXT
			TEXT
			TEXT
			TEXT

Menu Mode

Menu / Item		Available Values	Default
GENERAL			
05-01	NB WIDTH	1/3/10 (msec)	3msec
05-02	NB REJECTION	10/30/50 (dB)	30dB
05-03	NB LEVEL	0 - 10	5
05-04	BEEP LEVEL	0 - 100	30
05-05	RF/SQ/L VR	RF/SQ/L	RF
05-06	CAT RATE	4800/9600/19200/38400 (bps)	4800bps
05-07	CAT TOT	10/100/1000/3000 (msec)	10ms
05-08	CAT RTS	ENABLE/DISABLE	ENABLE
05-09	MEM GROUP	ENABLE/DISABLE	DISABLE
05-10	FM SETTING	ENABLE/DISABLE	DISABLE
05-11	REC SETTING	ENABLE/DISABLE	DISABLE
05-12	ATAS SETTING	ENABLE/DISABLE	DISABLE
05-13	QUICK SPL FREQ	-20 (kHz) - 0 - 20 (kHz)	5kHz
05-14	TX TOT	OFF/1 - 30 (min)	OFF (10 min [※])
05-15	MIC SCAN	ENABLE/DISABLE	ENABLE
05-16	MIC SCAN RESUME	PAUSE/TIME	TIME
05-17	REF FREQ ADJ	-25 - 0 - 25	0
05-18	CLAR SELECT	RX/TX/TRX	RX
05-19	APO	OFF/1/2/4/6/8/10/12 (h)	OFF
05-20	FAN CONTROL	NORMAL/CONTEST	NORMAL
MODE AM			
06-01	AM LCUT FREQ	OFF /100 - 1000 (Hz)	OFF
06-02	AM LCUT SLOPE	6 / 18 (dB/oct)	6dB/oct
06-03	AM HCUT FREQ	700 - 4000 (Hz) / OFF	OFF
06-04	AM HCUT SLOPE	6 / 18 (dB/oct)	6dB/oct
06-05	AM MIC SELECT	MIC/REAR	MIC
06-06	AM OUT LEVEL	0 - 100	50
06-07	AM PTT SELECT	DAKY/RTS/DTR	DAKY
MODE CW			
07-01	CW LCUT FREQ	OFF /100 - 1000 (Hz)	250Hz
07-02	CW LCUT SLOPE	6 / 18 (dB/oct)	18dB/oct
07-03	CW HCUT FREQ	700 - 4000 (Hz) / OFF	1200Hz
07-04	CW HCUT SLOPE	6 / 18 (dB/oct)	18dB/oct
07-05	CW OUT LEVEL	0 - 100	50
07-06	CW AUTO MODE	OFF/50M/ON	OFF
07-07	CW BFO	USB/LSB/AUTO	USB
07-08	CW BK-IN TYPE	SEMI/FULL	SEMI
07-09	CW BK-IN DELAY	30 - 3000 (msec)	200msec
07-10	CW WAVE SHAPE	2/4 (msec)	4msec
07-11	CW FREQ DISPLAY	FREQ/PITCH	PITCH
07-12	PC KEYING	OFF/DAKY/RTS/DTR	OFF
07-13	QSK DELAY TIME	15/20/25/30 (msec)	15msec
MODE DAT			
08-01	DATA MODE	PSK/OTHERS	PSK
08-02	PSK TONE	1000/1500/2000 (Hz)	1000Hz
08-03	OTHER DISP	-3000 - 0 - 3000 (Hz)	0Hz

※: European Version.

Menu Mode

Menu / Item		Available Values	Default
08-04	OTHER SHIFT	-3000 - 0 - 3000 (Hz)	0Hz
08-05	DATA LCUT FREQ	OFF /100 - 1000 (Hz)	300Hz
08-06	DATA LCUT SLOPE	6 / 18 (dB/oct)	18dB/oct
08-07	DATA HCUT FREQ	700 - 4000Hz / OFF	3000Hz
08-08	DATA HCUT SLOPE	6 / 18 (dB/oct)	18dB/oct
08-09	DATA IN SELECT	MIC/REAR	REAR
08-10	DATA PTT SELECT	DAKY/RTS/DTR	DAKY
08-11	DATA OUT LEVEL	0 - 100	50
08-12	DATA BFO	USB/LSB	LSB
MODE FM			
09-01	FM MIC SELECT	MIC/REAR	MIC
09-02	FM OUT LEVEL	0 - 100	50
09-03	PKT PTT SELECT	DAKY/RTS/DTR	DAKY
09-04	RPT SHIFT 28MHz	0 - 1000 (kHz)	100kHz
09-05	RPT SHIFT 50MHz	0 - 4000 (kHz)	1000kHz
09-06	DCS POLARITY	Tn-Rn/Tn-Riv/Tiv-Rn/Tiv-Riv	Tn-Rn
MODE RTY			
10-01	RTTY LCUT FREQ	OFF /100 - 1000 (Hz)	300Hz
10-02	RTTY LCUT SLOPE	6 / 18 (dB/oct)	18dB/oct
10-03	RTTY HCUT FREQ	700 - 4000 (Hz) / OFF	3000Hz
10-04	RTTY HCUT SLOPE	6 / 18 (dB/oct)	18dB/oct
10-05	RTTY SHIFT PORT	SHIFT/DTR/RTS	SHIFT
10-06	RTTY POLARITY-R	NOR/REV	NOR
10-07	RTTY POLARITY-T	NOR/REV	NOR
10-08	RTTY OUT LEVEL	0 - 100	50
10-09	RTTY SHIFT FREQ	170/200/425/850 (Hz)	170Hz
10-10	RTTY MARK FREQ	1275/2125 (Hz)	2125Hz
10-11	RTTY BFO	USB/LSB	LSB
MODE SSB			
11-01	SSB LCUT FREQ	OFF /100 - 1000 (Hz)	100Hz
11-02	SSB LCUT SLOPE	6 / 18 (dB/oct)	6dB/oct
11-03	SSB HCUT FREQ	700 - 4000 (Hz) / OFF	3000Hz
11-04	SSB HCUT SLOPE	6 / 18 (dB/oct)	6dB/oct
11-05	SSB MIC SELECT	MIC/REAR	MIC
11-06	SSB OUT LEVEL	0 - 100	50
11-07	SSB BFO	USB/LSB/AUTO	AUTO
11-08	SSB PTT SELECT	DAKY/RTS/DTR	DAKY
11-09	SSB TX BPF	100-3000/100-2900/200-2800/300-2700/400-2600	300-2700
RX DSP			
12-01	APF WIDTH	NARROW/MEDIUM/WIDE	MEDIUM
12-02	CONTOUR LEVEL	-40 - 0 - 20	-15
12-03	CONTOUR WIDTH	1 - 11	10
12-04	IF NOTCH WIDTH	NARROW/WIDE	WIDE
SCOPE			
13-01	SCP START CYCLE	OFF/3/5/10 (sec)	OFF
13-02	SCP SPAN FREQ	37.5/75/150/375/750 (kHz)	750kHz

Menu Mode

Menu / Item		Available Values	Default
TUNING			
14-01	QUICK DIAL	50/100/500 (kHz)	500kHz
14-02	SSB DIAL STEP	2/5/10 (Hz)	10Hz
14-03	AM DIAL STEP	10/100 (Hz)	10Hz
14-04	FM DIAL STEP	10/100 (Hz)	100Hz
14-05	DIAL STEP	2/5/10 (Hz)	5Hz
14-06	AM CH STEP	2.5/5/9/10/12.5/25 (kHz)	5kHz
14-07	FM CH STEP	5/6.25/10/12.5/15/20/25 (kHz)	5kHz
TX AUDIO			
15-01	EQ1 FREQ	OFF/100 - 700	OFF
15-02	EQ1 LEVEL	-20 - 0 - 10	5
15-03	EQ1 BWTH	1 - 10	10
15-04	EQ2 FREQ	OFF/700 - 1500	OFF
15-05	EQ2 LEVEL	-20 - 0 - 10	5
15-06	EQ2 BWTH	1 - 10	10
15-07	EQ3 FREQ	OFF/1500 - 3200	OFF
15-08	EQ3 LEVEL	-20 - 0 - 10	5
15-09	EQ3 BWTH	1 - 10	10
15-10	P-EQ1 FREQ	OFF/100 - 700	200
15-11	P-EQ1 LEVEL	-20 - 0 - 10	0
15-12	P-EQ1 BWTH	1 - 10	2
15-13	P-EQ2 FREQ	OFF/700 - 1500	800
15-14	P-EQ2 LEVEL	-20 - 0 - 10	0
15-15	P-EQ2 BWTH	1 - 10	1
15-16	P-EQ3 FREQ	OFF/1500 - 3200	2100
15-17	P-EQ3 LEVEL	-20 - 0 - 10	0
15-18	P-EQ3 BWTH	1 - 10	1
TX GNRL			
16-01	HF SSB PWR	5 - 100	100
16-02	HF AM PWR	5 - 40	25
16-03	HF PWR	5 - 100	100
16-04	50M SSB PWR	5 - 100	100
16-05	50M AM PWR	5 - 40	25
16-06	50M PWR	5 - 100	100
16-07	SSB MIC GAIN	0 - 100	50
16-08	AM MIC GAIN	0 - 100	50
16-09	FM MIC GAIN	0 - 100	50
16-10	DATA MIC GAIN	0 - 100	50
16-11	SSB DATA GAIN	0 - 100	50
16-12	AM DATA GAIN	0 - 100	50
16-13	FM DATA GAIN	0 - 100	50
16-14	DATA DATA GAIN	0 - 100	50
16-15	TUNER SELECT	OFF/EXTERNAL/ATAS/LAMP	OFF
16-16	VOX SELECT	MIC/DATA	MIC
16-17	VOX GAIN	0 - 100	50
16-18	VOX DELAY	30 - 3000 (msec)	500msec
16-19	ANTI VOX GAIN	0 - 100	50
16-20	DATA VOX GAIN	0 - 100	50

Menu Mode

Menu / Item		Available Values	Default
16-21	DATA VOX DELAY	30 - 3000 (msec)	100msec
16-22	ANTI DVOX GAIN	0 - 100	0
16-23	EMERGENCY FREQ	ENABLE/DISABLE	DISABLE
RESET			
17-01	RESET	ALL/DATA/FUNC	---
VERSION			
18-01	MAIN VERSION	---	---
18-02	DSP VERSION	---	---
18-03	LCD VERSION	---	---

01-01 AGC FAST DELAY

Function: Sets the AGC-FAST DELAY voltage decay characteristics.

Available Values: 20 - 4000msec (20msec/step)

Default: 300msec

Description: Sets the AGC voltage decay characteristics in 20 msec steps after the input signal level becomes lower than the AGC detection level and the HOLD time is over.

01-02 AGC MID DELAY

Function: Sets the AGC-MID DELAY voltage decay characteristics.

Available Values: 20 - 4000msec (20msec/step)

Default: 700msec

Description: Sets the AGC voltage decay characteristics in 20 msec steps after the input signal level becomes lower than the AGC detection level and the HOLD time is over.

01-03 AGC SLOW DELAY

Function: Sets the AGC-SLOW DELAY voltage decay characteristics.

Available Values: 20 - 4000msec (20msec/step)

Default: 3000msec

Description: Sets the AGC voltage decay characteristics in 20 msec steps after the input signal level becomes lower than the AGC detection level and the HOLD time is over.

02-01 LCD CONTRAST

Function: Sets the display contrast level.

Available Values: 1 - 15

Default: 8

02-02 DIMMER BACKLIT

Function: Sets the key LED brightness level.

Available Values: 1 - 15

Default: 8

Description: Sets the brightness level of the key LED. The effect of the changes may be observed as the brightness level is adjusted. The higher the setting, the brighter the illumination becomes.

02-03 DIMMER LCD

Function: Sets the LCD display brightness level.

Available Values: 1 - 15

Default: 8

Description: Sets the brightness level of the LCD display. The effect of the changes may be observed as the brightness level is adjusted. The higher the setting, the brighter the illumination becomes.

02-04 DIMMER TX/BUSY

Function: Sets the TX/BUSY Indicator brightness level.

Available Values: 1 - 15

Default: 8

Description: Sets the brightness level of the TX/BUSY Indicator. The effect of the changes may be observed as the brightness level is adjusted. The higher the setting, the brighter the illumination becomes.

02-05 PEAK HOLD

Function: Sets the meter peak hold.

Available Values: OFF/0.5/1.0/2.0 (sec)

Default: OFF

Description: Sets the time length the maximum value reading is shown on the meter (peak hold).

OFF: Disables the peak hold function.

0.5/1.0/2.0: Holds the maximum value for the time length that is set.

02-06 ZIN LED

Function: Enables/Disables the zero in indicator (TX/BUSY indicator).

Available Values: ENABLE/DISABLE

Default: DISABLE

02-07 POP-UP MENU

Function: Set the display position of the pop-up screen.

Available Values: UPPER/LOWER

Default: LOWER

03-01 DVS RX OUT LEVE

Function: Sets the voice memory monitoring level.

Available Values: 0 - 100

Default: 50

Description: You can adjust the voice memory monitoring level. The higher the setting, the higher the out-put level becomes.

03-02 DVS TX OUT LVL

Function: Sets the microphone output level for the voice memory.

Available Values: 0 - 100

Default: 50

Description: The microphone output level may be adjusted to the operators own voice and preference. For example, the output level may be set differently between the microphone and the voice memory. The higher the setting, the higher the output level becomes.

04-01 KEYER TYPE

Function: Switches the keyer operation.

Available Values: OFF/BUG/ELEKEY-A/ELEKEY-B/ELEKEY-Y/ACS

Default: ELEKEY-B

Description: Switches the keyer operation.

OFF: Disables the keyer function.

BUG: Functions as a "BUG key". Only the "Dot" side is automatically generated (the "Dash" side is generated manually).

ELEKEY-A: A code elements ("Dot" or "Dash") are automatically transmitted upon pressing either side of the paddle.

ELEKEY-B: Pressing both sides of the paddle transmits the currently generated "Dash" followed by the "Dot" (or reverse order).

ELEKEY-Y: Pressing both sides of the paddle transmits the currently generated "Dash" followed by the "Dot" (or reverse order). While transmitting the "Dash", the first transmitted "Dot" will not be stored.

ACS: Same as "ELEKEY" except that the spacing between characters is precisely set by the keyer to be the same length as a dash (three dots in length).

04-02 KEYER DOT/DASH

Function: Reverses the connections of the CW paddle key jack.

Available Values: NOR/REV

Default: NOR

Description: Reverses the connections of the CW paddle.

NOR: Press the right side of the paddle to transmit the "Dot" signal and press the left side of the paddle to transmit the "Dash" signal.

REV: Press the left side of the paddle to transmit the "Dash" signal and press the right side of the paddle to transmit the "Dot" signal.

04-03 CW WEIGHT

Function: Adjusts the keyer CW weight.

Available Values: 2.5 - 4.5

Default: 3.0

Description: Sets the "Dot": "Dash" ratio for the built-in electronic keyer.

04-04 BEACON INTERVAL

Function: Sets the interval time between repeats of the beacon message.

Available Values: OFF/1 - 240 (sec) (1 sec/step) 270 - 690 (sec) (30 sec/step)

Default: OFF

Description: Sets the interval time between repeats of the beacon message. A message (message memory/text memory) registered in the contest memory keyer, may be transmitted as a CW Beacon message. If you do not want the message to repeat in a beacon mode, set this item to "OFF".

04-05 NUMBER STYLE

Function: Selects the contest number "Cut" format for an embedded contest number.

Available Values: 1290/AUNO/AUNT/A2NO/A2NT/12NO/12NT

Default: 1290

Description: Abbreviates numbers "One", "Two", "Nine" and "Zero" using Morse code when sending the contest number.

1290: Does not abbreviate the contest number.

AUNO: Abbreviates to "A" for "One", "U" for "Two", "N" for "Nine", and "O" for "Zero".

AUNT: Abbreviates to "A" for "One", "U" for "Two", "N" for "Nine", and "T" for "Zero".

A2NO: Abbreviates to "A" for "One", "N" for "Nine", and "O" for "Zero". Does not abbreviate number "Two".

A2NT: Abbreviates to "A" for "One", "N" for "Nine", and "T" for "Zero". Does not abbreviate number "Two".

12NO: Abbreviates to "N" for "Nine", and "O" for "Zero". Does not abbreviate numbers "One" and "Two".

12NT: Abbreviates to "N" for "Nine", and "T" for "Zero". Does not abbreviate numbers "One" and "Two".

04-06 CONTEST NUMBER

Function: Enters the contest number using Morse code.

Available Values: 0 - 9999

Default: 1

Description: Enters the contest number using Morse code (see page 23).

04-07 CW MEMORY 1

Function: Selects the registration method for the contest memory keyer "CW MEMORY 1".

Available Values: TEXT/MESSAGE

Default: TEXT

Description: Selects how to register text to the contest memory keyer "CW MEMORY 1".

TEXT: Use the optional FH-2 or the **MULTI** function knob to enter text (see page 17).

MESSAGE: Use the keyer to register text to the contest memory keyer (see page 11).

04-08 CW MEMORY 2

Function: Selects the registration method for the contest memory keyer “CW MEMORY 2”.

Available Values: TEXT/MESSAGE

Default: TEXT

Description: Selects how to register text to the contest memory keyer “CW MEMORY 2”.

TEXT: Use the optional FH-2 or the **MULTI** function knob to enter text (see page 17).

MESSAGE: Use the keyer to register text to the contest memory keyer (see page 11).

04-09 CW MEMORY 3

Function: Selects the registration method for the contest memory keyer “CW MEMORY 3”.

Available Values: TEXT/MESSAGE

Default: TEXT

Description: Selects how to register text to the contest memory keyer “CW MEMORY 3”.

TEXT: Use the optional FH-2 or the **MULTI** function knob to enter text (see page 17).

MESSAGE: Use the keyer to register text to the contest memory keyer (see page 11).

04-10 CW MEMORY 4

Function: Selects the registration method for the contest memory keyer “CW MEMORY 4”.

Available Values: TEXT/MESSAGE

Default: TEXT

Description: Selects how to register text to the contest memory keyer “CW MEMORY 4”.

TEXT: Use the optional FH-2 or the **MULTI** function knob to enter text (see page 17).

MESSAGE: Use the keyer to register text to the contest memory keyer (see page 11).

04-11 CW MEMORY 5

Function: Selects the registration method for the contest memory keyer “CW MEMORY 5”.

Available Values: TEXT/MESSAGE

Default: TEXT

Description: Selects how to register text to the contest memory keyer “CW MEMORY 5”.

TEXT: Use the optional FH-2 or the **MULTI** function knob to enter text (see page 17).

MESSAGE: Use the keyer to register text to the contest memory keyer (see page 11).

05-01 NB WIDTH

Function: Sets the duration of the noise blanking pulse to match various types of noise compatible with the noise blanker function.

Available Values: 1/3/10 (msec)

Default: 3msec

Description: Reduces long duration noise as well as pulse noise by changing the setting.

05-02 NB REJECTION

Function: Selects the level of noise attenuation.

Available Values: 10/30/50 (dB)

Default: 30dB

05-03 NB LEVEL

Function: Sets the noise blanker level.

Available Values: 0 - 10

Default: 5

Description: Sets the noise blanker level to reduce pulse noise such as noise caused by automotive ignition systems. The higher the setting, the higher the noise blanker level becomes.

05-04 BEEP LEVEL

Function: Sets the beep level.

Available Values: 0 - 100

Default: 30

Description: Sets the beep sound volume level. The higher the setting, the louder the sound becomes.

05-05 RF/SQL VR

Function: Select the operation mode of the RF/SQL knob.

Available Values: RF/SQL VR

Default: RF

05-06 CAT RATE

Function: Sets the baud rate for a CAT command input.

Available Values: 4800/9600/19200/38400 (bps)

Default: 4800bps

Description: Sets the baud rate for a CAT command input.

05-07 CAT TOT

Function: Sets the Time-Out Timer for a CAT command input.

Available Values: 10/100/1000/3000 (msec)

Default: 10ms

Description: Sets the Time-Out Timer countdown time for a CAT command input.

05-08 CAT RTS

Function: Configures the CT RTS port setting.

Available Values: ENABLE/DISABLE

Default: ENABLE

Description: Monitors the computer using the RTS signal.

ENABLE: Monitors the computer status using the RTS signal.

DISABLE: Disables the monitoring function.

05-09 MEM GROUP

Function: Sets the memory group function.

Available Values: ENABLE/DISABLE

Default: DISABLE

Description: Set this setting to "ENABLE" to divide the memory channels into 6 groups.

05-10 FM SETTING

Function: Sets the "FM SETTING" screen.

Available Values: ENABLE/DISABLE

Default: DISABLE

05-11 REC SETTING

Function: Sets the "REC SETTING" screen.

Available Values: ENABLE/DISABLE

Default: DISABLE

05-12 ATAS SETTING

Function: Sets the "ATAS SETTING" screen.

Available Values: ENABLE/DISABLE

Default: DISABLE

05-13 QUICK SPL FREQ

Function: Selects the amount of frequency offset when the Quick Split feature is enabled.

Available Values: -20 (kHz) - 0 - 20 (kHz)

Default: 5kHz

Description: Sets the amount of frequency offset when the Quick Split feature is enabled.

05-14 TX TOT

Function: Sets the Time-Out Timer countdown time.

Available Values: OFF/1 - 30 (min)

Default: OFF (10 min for European Version)

Description: Forces the transceiver to return to receiving mode after continuous transmission of the programmed time.

05-15 MIC SCAN

Function: Sets the microphone automatic scanning function to ON or OFF.

Available Values: ENABLE/DISABLE

Default: ENABLE

Description: Selects the operation of the [UP]/[DWN] keys on the microphone.

ENABLE (ON): Starts scanning automatically by pressing and holding the [UP] or [DWN] key for 1 second or more (Scanning continues even after releasing the key). To stop scanning, press the [UP] or [DWN] key again briefly or press the PTT switch to transmit.

DISABLE (OFF): Scans only while pressing and holding the [UP]/[DWN] button. To stop scanning, release the key.

05-16 MIC SCAN RESUME

Function: Sets the Scan Resume function.

Available Values: PAUSE/TIME

Default: TIME

Description: Sets the Scan Resume function (in AM/FM mode).

PAUSE: During automatic scanning, the scanner will hold until the signal disappears.

TIME: If the signal does not disappear within five seconds, the scanner will resume scanning for the next active channel (frequency). If there is no signal, the scanner continues scanning automatically.

05-17 REF FREQ ADJ

Function: Adjusts the reference oscillator.

Available Values: -25 - 0 - 25

Default: 0

Description: The frequency may be calibrated when connecting a frequency counter to the transceiver, or when receiving a standard frequency such as WWV or WWVH.

05-18 CLAR SELECT

Function: Selects the clarifier operation

Available Values: RX/TX/TRX

Default: RX

Description: Selects the clarifier operation when the [CLAR] key is pressed.

RX: Functions as the RX clarifier which changes only the receiver frequency without changing transmit frequency.

TX: Functions as the TX clarifier which changes only the transmit frequency without changing the receiver frequency.

TRX: Functions as the TRX clarifier which changes the transmit frequency and the receiver frequency simultaneously.

05-19 APO

Function: Select the Auto Power Off time (time before power goes off).

Available Values: OFF/1/2/4/6/8/10/12 (h)

Default: OFF

05-20 FAN CONTROL

Function: The cooling fan can be set to operate for two different temperature conditions.

Available Values: NORMAL/CONTEST

Default: NORMAL

06-01 AM LCUT FREQ

Function: Sets the low-frequency cutoff audio filter in AM mode.

Available Values: OFF /100 - 1000 (Hz)

Default: OFF

Description: This is the low-frequency cutoff audio filter in AM mode. The cutoff frequency can be set at 50 Hz increments between 100 Hz and 1000 Hz.

06-02 AM LCUT SLOPE

Function: Sets the slope of the low-frequency cutoff audio filter in AM mode.

Available Values: 6 / 18 (dB/oct)

Default: 6dB/oct

Description: Selects the slope of the low-frequency cut-off audio filter in AM mode.

06-03 AM HCUT FREQ

Function: Sets the high-frequency cutoff audio filter in AM mode.

Available Values: 700 - 4000 (Hz) / OFF

Default: OFF

Description: This is the high-frequency cutoff audio filter in AM mode. The cutoff frequency can be set at 50 Hz increments between 700 Hz and 4000 Hz.

06-04 AM HCUT SLOPE

Function: Sets the slope of the high-frequency cutoff audio filter in AM mode.

Available Values: 6 / 18 (dB/oct)

Default: 6dB/oct

Description: Selects the slope of the high-frequency cut-off audio filter in AM mode.

06-05 AM MIC SELECT

Function: Selects the microphone input jack for AM mode.

Available Values: MIC/REAR

Default: MIC

Description: Selects the microphone input jack to be used in AM mode.

MIC: Audio is input from the MIC jack on the front panel.

REAR: Disables the microphone circuit on the front panel and inputs audio/data from the RTTY/DATA jack on the rear panel.

06-06 AM OUT LEVEL

Function: Sets the level of the receive AM signal output from the RTTY/DATA jack.

Available Values: 0 - 100

Default: 50

06-07 AM PTT SELECT

Function: Sets the PTT control for the AM transmit signal.

Available Values: DAKY/RTS/DTR

Default: DAKY

Description: Selects the PTT control method for the AM transmit.

DAKY: Controls the AM transmit signal from the RTTY/DATA jack (pin 3) on the rear panel.

DTR: Controls the AM transmit signal from the USB virtual COM/DTR ports.

RTS: Controls the AM transmit signal from the USB virtual COM/RTS ports.

07-01 CW LCUT FREQ

Function: Sets the low-frequency cutoff audio filter in CW mode.

Available Values: OFF /100 - 1000 (Hz)

Default: 250Hz

Description: This is the low-frequency cutoff audio filter in CW mode. The cutoff frequency can be set at 50 Hz increments between 100 Hz and 1000 Hz.

07-02 CW LCUT SLOPE

Function: Sets the slope of the low-frequency cutoff audio filter in CW mode.

Available Values: 6 / 18 (dB/oct)

Default: 18dB/oct

Description: Selects the slope of the low-frequency cutoff audio filter in CW mode.

07-03 CW HCUT FREQ

Function: Sets the high-frequency cutoff audio filter in CW mode.

Available Values: 700 - 4000 (Hz) / OFF

Default: 1200Hz

Description: This is the high-frequency cutoff audio filter in CW mode.

The cutoff frequency can be set at 50 Hz increments between 700 Hz and 4000 Hz.

07-04 CW HCUT SLOPE

Function: Sets the slope of the high-frequency cutoff audio filter in CW mode.

Available Values: 6 / 18 (dB/oct)

Default: 18dB/oct

Description: Selects the slope of the high-frequency cutoff audio filter in CW mode.

07-05 CW OUT LEVEL

Function: Sets the level of the CW signal output from the RTTY/DATA jack.

Available Values: 0 - 100

Default: 50

07-06 CW AUTO MODE

Function: Enables/disables CW keying while operating on SSB.

Available Values: OFF/50M/ON

Default: OFF

Description: **OFF:** Disables CW keying while operating on SSB.

50M: Enables CW keying while operating SSB on 50 MHz (but not HF).

ON: Enables CW keying while operating SSB on all TX bands.

07-07 CW BFO

Function: Sets the CW carrier oscillator injection side for the CW mode.

Available Values: USB/LSB/AUTO

Default: USB

Description: **USB:** Injects the CW carrier oscillator on the USB side.

LSB: Injects the CW carrier oscillator on the LSB side.

AUTO: Injects the CW carrier oscillator on the LSB side while operating on the 7 MHz band and below, and the USB side while operating on the 10 MHz band and up.

07-08 CW BK-IN TYPE

Function: Sets the CW brake-in function.

Available Values: SEMI/FULL

Default: SEMI

Description: Selects the CW brake-in function.

SEMI: A brief delay is provided after the CW keying operation, before the transceiver returns to receive mode.

The receiver recovery time may be changed using Menu Mode "07-09 [CW BK-IN DELAY]".

FULL: The transceiver immediately returns to receive mode after every CW key-up (QSK mode).

07-09 CW BK-IN DELAY

Function: Sets the CW delay time.

Available Values: 30 - 3000 (msec)

Default: 200msec

Description: In semi break-in mode, this setting determines the delay time before returning to receive mode after the CW keying operation.

The delay time can be changed in 10 msec steps between 30 msec and 3000 msec.

07-10 CW WAVE SHAPE

Function: Selects the CW carrier wave-form shape (rise/fall times).

Available Values: 2/4 (msec)

Default: 4msec

Description: Sets the rise and fall times of the keying envelope in CW mode (transmit waveform).

07-11 CW FREQ DISPLAY

Function: Sets the PITCH frequency offset.

Available Values: FREQ/PITCH

Default: PITCH

Description: Sets the displayed frequency offset when switching the transceiver mode between SSB and CW.

FREQ: Displays the same frequency in CW mode as in SSB mode without any offset added.

PITCH: Displays the frequency in CW mode with the pitch offset added. When CW BFO is set to USB, the displayed frequency will be increased and when CW BFO is set to LSB, the displayed frequency will be decreased with pitch offset added.

07-12 PC KEYING

Function: Sets the RTTY/DATA jack for keying.

Available Values: OFF/DAKY/RTS/DTR

Default: OFF

Description: **OFF:** Disables keying from DATA PTT (pin 3) of the RTTY/DATA jack.

DAKY: Controls the transmit from the RTTY/DATA jack (pin 3) on the rear panel.

RTS: Controls the transmit from the USB virtual COM/RTS ports.

DTR: Controls the transmit from the USB virtual COM/DTR ports.

07-13 QSK DELAY TIME

Function: Sets the time delay before transmitting the keying signal.

Available Values: 15/20/25/30 (msec)

Default: 15msec

Description: The delay time in QSK mode before transmitting the CW signal may be set in 5 msec steps.

08-01 DATA MODE

Function: Selects the operating scheme in DATA mode.

Available Values: PSK/OTHERS

Default: PSK

Description: Selects the operating scheme (PSK or OTHERS) in DATA mode.

08-02 PSK TONE

Function: Set the PSK tone.

Available Values: 1000/1500/2000 (Hz)

Default: 1000Hz

Description: Selects the PSK tone frequency.

08-03 OTHER DISP

Function: Sets the displayed frequency offset in DATA mode.

Available Values: -3000 - 0 - 3000 (Hz)

Default: 0Hz

Description: Sets the displayed frequency offset in DATA mode. The frequency can be set in steps of 10 Hz.

08-04 OTHER SHIFT

Function: Sets the carrier point in DATA mode.

Available Values: -3000 - 0 - 3000 (Hz)

Default: 0Hz

Description: Sets the carrier point in DATA mode. The frequency can be set in steps of 10 Hz.

08-05 DATA LCUT FREQ

Function: Sets the low-frequency cutoff audio filter in DATA mode.

Available Values: OFF /100 - 1000 (Hz)

Default: 300Hz

Description: This is the low-frequency cutoff audio filter in DATA mode.
The cutoff frequency can be set at 50 Hz increments between 100 Hz and 1000 Hz.

08-06 DATA LCUT SLOPE

Function: Sets the slope of the low-frequency cutoff audio filter in DATA mode.

Available Values: 6 / 18 (dB/oct)

Default: 18dB/oct

Description: Selects the slope setting of the low-frequency cutoff audio filter in DATA mode.

08-07 DATA HCUT FREQ

Function: Sets the high-frequency cutoff audio filter in DATA mode.

Available Values: 700 - 4000Hz / OFF

Default: 3000Hz

Description: This is the high-frequency cutoff audio filter in DATA mode.
The cutoff frequency can be set at 50 Hz increments between 700 Hz and 4000 Hz.

08-08 DATA HCUT SLOPE

Function: Sets the slope of the high-frequency cutoff audio filter in DATA mode.

Available Values: 6 / 18 (dB/oct)

Default: 18dB/oct

Description: Selects the slope setting of the high-frequency cutoff audio filter in DATA mode.

08-09 DATA IN SELECT

Function: Selects the input jack for DATA mode.

Available Values: MIC/REAR

Default: REAR

Description: Selects the input jack to be used in DATA mode.

MIC: Inputs signals from the MIC jack on the front panel.

REAR: Inputs signals from the RTTY/DATA jack on the rear panel.

08-10 DATA PTT SELECT

Function: Sets the PTT control during the sending/receiving of data.

Available Values: DAKY/RTS/DTR

Default: DAKY

Description: Selects the PTT control method during the sending/receiving of data.

DAKY: Controls the transmit from the RTTY/DATA jack (pin 3) on the rear panel.

DTR: Controls the transmit from the USB virtual COM/DTR ports.

RTS: Controls the transmit from the USB virtual COM/RTS ports.

08-11 DATA OUT LEVEL

Function: Sets the output level during the sending/receiving of data (PSK31, SSTV, etc.).

Available Values: 0 - 100

Default: 50

Description: Sets the output level during the sending/receiving of data (PSK31, SSTV, etc.). The higher the setting, the higher the output level becomes.

08-12 DATA BFO

Function: Sets the DATA carrier oscillator injection side for the DATA mode.

Available Values: USB/LSB

Default: LSB

Description: **USB:** Injects the DATA carrier oscillator on the USB side.

LSB: Injects the DATA carrier oscillator on the LSB side.

09-01 FM MIC SELECT

Function: Selects the microphone input jack for FM mode.

Available Values: MIC/REAR

Default: MIC

Description: Selects the microphone input jack to be used in FM mode.

MIC: Inputs from the MIC jack on the front panel.

REAR: Disables the microphone circuit on the front panel and inputs from the RTTY/DATA jack on the rear panel.

09-02 FM OUT LEVEL

Function: Sets the level of the FM receiving signal output from the RTTY/DATA jack.

Available Values: 0 - 100

Default: 50

09-03 PKT PTT SELECT

Function: Sets the PTT control for the FM signal.

Available Values: DAKY/RTS/DTR

Default: DAKY

Description: Selects the PTT control method for the FM signal.

DAKY: Controls the transmit from the RTTY/DATA jack (pin 3) on the rear panel.

RTS: Controls the transmit from the USB virtual COM/RTS ports.

DTR: Controls the transmit from the USB virtual COM/DTR ports.

09-04 RPT SHIFT 28MHz

Function: Sets the RPT offset frequency on the 28 MHz band.

Available Values: 0 - 1000 (kHz)

Default: 100kHz

Description: Sets the repeater offset frequency on the 28 MHz band.

09-05 RPT SHIFT 50MHz

Function: Sets the RPT offset frequency on the 50 MHz band.

Available Values: 0 - 4000 (kHz)

Default: 1000kHz

Description: Sets the repeater offset frequency on the 50 MHz band.

09-06 DCS POLARITY

Function: Selects the DCS code polarity.

Available Values: Tn-Rn/Tn-Riv/Tiv-Rn/Tiv-Riv

Default: Tn-Rn

Description: When using the DCS function, the transceiver can transmit/receive the DCS code with the phase reversed.

Tn-Rn: Transmit (in phase), receive (in phase)

Tn-Riv: Transmit (in phase), receive (reverse phase)

Tiv-Rn: Transmit (reverse phase), receive (in phase)

Tiv-Riv: Transmit (reverse phase), receive (reverse phase)

10-01 RTTY LCUT FREQ

Function: Sets the low-frequency cutoff audio filter in RTTY mode.

Available Values: OFF /100 - 1000 (Hz)

Default: 300Hz

Description: This is the low-frequency cutoff audio filter in RTTY mode.

The cutoff frequency can be set at 50 Hz increments between 100 Hz and 1000 Hz.

10-02 RTTY LCUT SLOPE

Function: Sets the slope of the low-frequency cutoff audio filter in RTTY mode.

Available Values: 6 / 18 (dB/oct)

Default: 18dB/oct

Description: Selects the slope setting of the low-frequency cutoff audio filter in RTTY mode.

10-03 RTTY HCUT FREQ

Function: Sets the high-frequency cutoff audio filter in RTTY mode.

Available Values: 700 - 4000 (Hz) / OFF

Default: 3000Hz

Description: This is the high-frequency cutoff audio filter in RTTY mode.

The cutoff frequency can be set at 50 Hz increments between 700 Hz and 4000 Hz.

10-04 RTTY HCUT SLOPE

Function: Sets the slope of the high-frequency cutoff audio filter in RTTY mode.

Available Values: 6 / 18 (dB/oct)

Default: 18dB/oct

Description: Selects the slope setting of the high-frequency cutoff audio filter in RTTY mode.

10-05 RTTY SHIFT PORT

Function: Sets the SHIFT input jack for RTTY mode.

Available Values: SHIFT/DTR/RTS

Default: SHIFT

Description: Selects the SHIFT input jack for RTTY mode.

SHIFT: Inputs from the RTTY/DATA jack (pin 4) on the rear panel.

DTR: Controls the signal from the USB virtual COM/DTR ports.

RTS: Controls the signal from the USB virtual COM/RTS ports.

10-06 RTTY POLARITY-R

Function: Sets the shift direction for receiving in RTTY mode.

Available Values: NOR/REV

Default: NOR

Description: Sets the shift direction for receiving in RTTY mode.

NOR: The space frequency will be lower than the mark frequency.

REV: The mark frequency will be lower than the space frequency.

10-07 RTTY POLARITY-T

Function: Sets the shift direction for transmitting in RTTY mode.

Available Values: NOR/REV

Default: NOR

Description: Sets the shift direction for transmitting in RTTY mode.

NOR: The space frequency will be lower than the mark frequency.

REV: The mark frequency will be lower than the space frequency.

10-08 RTTY OUT LEVEL

Function: Sets the output level during the sending/receiving of data in RTTY mode.

Available Values: 0 - 100

Default: 50

Description: Sets the data output level during the sending/receiving of data in RTTY mode. The higher the setting, the higher the output level becomes.

10-09 RTTY SHIFT FREQ

Function: Sets the shift width for RTTY mode.

Available Values: 170/200/425/850 (Hz)

Default: 170Hz

Description: Sets the shift width for RTTY mode.

10-10 RTTY MARK FREQ

Function: Sets the mark frequency for RTTY mode.

Available Values: 1275/2125 (Hz)

Default: 2125Hz

Description: Sets the mark frequency for RTTY mode.

10-11 RTTY BFO

Function: Sets the RTTY carrier oscillator injection side for the RTTY mode.

Available Values: USB/LSB

Default: LSB

Description: **USB:** Injects the RTTY carrier oscillator on the USB side.

LSB: Injects the RTTY carrier oscillator on the LSB side.

11-01 SSB LCUT FREQ

Function: Sets the low-frequency cutoff audio filter in SSB mode.

Available Values: OFF /100 - 1000 (Hz)

Default: 100Hz

Description: This is the low-frequency cutoff audio filter in SSB mode.

The cutoff frequency can be set at 50 Hz increments between 100 Hz and 1000 Hz.

11-02 SSB LCUT SLOPE

Function: Sets the slope of the low-frequency cutoff audio filter in SSB mode.

Available Values: 6 / 18 (dB/oct)

Default: 6dB/oct

Description: Selects the slope setting of the low-frequency cutoff audio filter in SSB mode.

11-03 SSB HCUT FREQ

Function: Sets the high-frequency cutoff audio filter in SSB mode.

Available Values: 700 - 4000 (Hz) / OFF

Default: 3000Hz

Description: This is the high-frequency cutoff audio filter in SSB mode.

The cutoff frequency can be set at 50 Hz increments between 700 Hz and 4000 Hz.

11-04 SSB HCUT SLOPE

Function: Sets the slope of the high-frequency cutoff audio filter in SSB mode.

Available Values: 6 / 18 (dB/oct)

Default: 6dB/oct

Description: Selects the slope setting of the high-frequency cutoff audio filter in SSB mode.

11-05 SSB MIC SELECT

Function: Selects the microphone input jack for SSB mode.

Available Values: MIC/REAR

Default: MIC

Description: Selects the microphone input jack to be used in SSB mode.

MIC: Inputs from the MIC jack on the front panel.

REAR: Disables the microphone circuit on the front panel and inputs from the RTTY/DATA jack on the rear panel.

11-06 SSB OUT LEVEL

Function: Sets the level of the SSB receiving signal output from the RTTY/DATA jack.

Available Values: 0 - 100

Default: 50

11-07 SSB BFO

Function: Sets the SSB carrier oscillator injection side for the SSB mode.

Available Values: USB/LSB/AUTO

Default: AUTO

Description: **USB:** Injects the SSB carrier oscillator on the USB side.

LSB: Injects the SSB carrier oscillator on the LSB side.

AUTO: Injects the SSB carrier oscillator on the LSB side while operating on the 7 MHz band and below, and the USB side while operating on the 10 MHz band and up.

11-08 SSB PTT SELECT

Function: Sets the PTT transmit control for the SSB signal.

Available Values: DAKY/RTS/DTR

Default: DAKY

Description: Selects the PTT transmit control method for the SSB signal.

DAKY: Controls the transmit signal from the RTTY/DATA jack (pin 3) on the rear panel.

DTR: Controls the transmit signal from the USB virtual COM/DTR ports.

RTS: Controls the transmit signal from the USB virtual COM/RTS ports.

11-09 SSB TX BPF

Function: Sets the frequency characteristics of the DSP band-pass filter for transmitting in SSB mode.

Available Values: 100-3000/100-2900/200-2800/300-2700/400-2600

Default: 300-2700 Hz

Description: Selects the frequency characteristics setting of the DSP band-pass filter when transmitting in SSB mode.

12-01 APF WIDTH

Function: Sets the bandwidth of the audio peak filter.

Available Values: NARROW/MEDIUM/WIDE

Default: MEDIUM

Description: In CW mode the APF peak center frequency is set according to the CW PITCH frequency and the chosen APF bandwidth value. In order to listen to the desired signal comfortably, select one of the three bandwidths of the peak filter.

12-02 CONTOUR LEVEL

Function: Adjusts the GAIN of the CONTOUR circuit.

Available Values: -40 - 0 - 20

Default: -15

Description: Sets level of the attenuation or the gain of the CONTOUR circuit.

12-03 CONTOUR WIDTH

Function: Sets the bandwidth (“Q”) of the CONTOUR circuit.

Available Values: 1 - 11

Default: 10

Description: Sets the bandwidth (WIDTH) of the CONTOUR circuit.

12-04 IF NOTCH WIDTH

Function: Sets the attenuation bandwidth characteristic of the DSP IF notch filter on the VFO-A.

Available Values: NARROW/WIDE

Default: WIDE

Description: Selects the attenuation bandwidth characteristic setting of the DSP IF notch filter to “NARROW” or “WIDE”.

13-01 SCP START CYCLE

Function: Selects the sweep interval of the Spectrum Scope feature.

Available Values: OFF/3/5/10 (sec)

Default: OFF

Description: The scope spectrum is repeatedly swept according the set interval.

13-02 SCP SPAN FREQ

Function: Sets the bandwidth of the spectrum scope sweeping.

Available Values: 37.5/75/150/375/750 (kHz)

Default: 750kHz

Description: Sets the bandwidth (SPAN) of the spectrum scope.

14-01 QUICK DIAL

Function: Setting of the MULTI function knob tuning speed in the SSB, CW, RTTY and DATA mode.

Available Values: 50/100/500 (kHz)

Default: 500kHz

14-02 SSB DIAL STEP

Function: Setting of the DIAL knob tuning speed in the SSB mode.

Available Values: 2/5/10 (Hz)

Default: 10Hz

14-03 AM DIAL STEP

Function: Setting of the **DIAL** knob tuning speed in the AM mode.

Available Values: 10/100 (Hz)

Default: 10Hz

14-04 FM DIAL STEP

Function: Setting of the **DIAL** knob tuning speed in the FM mode.

Available Values: 10/100 (Hz)

Default: 100Hz

14-05 DIAL STEP

Function: Setting of the **DIAL** knob tuning speed.

Available Values: 2/5/10 (Hz)

Default: 5Hz

14-06 AM CH STEP

Function: Selects the tuning steps for the **MULTI** function knob and the microphone's [UP]/[DWN] keys in the AM mode.

Available Values: 2.5/5/9/10/12.5/25 (kHz)

Default: 2.5kHz

14-07 FM CH STEP

Function: Selects the tuning steps for the **MULTI** function knob and the microphone's [UP]/[DWN] keys in the FM mode.

Available Values: 5/6.25/10/12.5/15/20/25 (kHz)

Default: 5kHz

15-01 EQ1 FREQ

Function: Sets the center frequency of the low range for the 3 band parametric microphone equalizer.

Available Values: OFF/100 - 700

Default: OFF

Description: Selects the center frequency setting of the low range of the 3 band parametric microphone equalizer between "100 Hz" and "700 Hz".

15-02 EQ1 LEVEL

Function: Sets the gain for the low range of the 3 band parametric microphone equalizer.

Available Values: -20 - 0 - 10

Default: 5

Description: Adjusts the gain for the low range of the 3 band parametric microphone equalizer between "-20 dB" and "+10 dB".

15-03 EQ1 BWTH

Function: Sets the width variation (“Q”) for the low range of the 3 band parametric microphone equalizer.

Available Values: 1 - 10

Default: 10

Description: Selects the value of the width (Q) for the low range for the 3 band parametric microphone equalizer between “1” and “10”.

15-04 EQ2 FREQ

Function: Sets the center frequency for the middle range of the 3 band parametric microphone equalizer.

Available Values: OFF/700 - 1500

Default: OFF

Description: Selects the center frequency setting for the middle range of the 3 band parametric microphone equalizer between “700 Hz” and “1500 Hz”.

15-05 EQ2 LEVEL

Function: Sets the gain for the middle range of the 3 band parametric microphone equalizer.

Available Values: -20 - 0 - 10

Default: 5

Description: Selects the gain setting for the middle range of the 3 band parametric microphone equalizer between “-20 dB” and “+10 dB”.

15-06 EQ2 BWTH

Function: Sets the width variation (“Q”) for the middle range of the 3 band parametric microphone equalizer.

Available Values: 1 - 10

Default: 10

Description: Selects the width (“Q”) for the middle range of the 3 band parametric microphone equalizer between “1” and “10”.

15-07 EQ3 FREQ

Function: Sets the center frequency for the high range of the 3 band parametric microphone equalizer.

Available Values: OFF/1500 - 3200

Default: OFF

Description: Selects the center frequency setting for the high range of the 3 band parametric microphone equalizer between “1500 Hz” and “3200 Hz”.

15-08 EQ3 LEVEL

Function: Sets the gain for the high range of the 3 band parametric microphone equalizer.

Available Values: -20 - 0 - 10

Default: 5

Description: Selects the gain setting for the high range of the 3 band parametric microphone equalizer between “-20 dB” and “+10 dB”.

15-09 EQ3 BWTH

Function: Selects the width setting (“Q”) for the high range of the 3 band parametric microphone equalizer.

Available Values: 1 - 10

Default: 10

Description: Selects the width (“Q”) setting for the high range of the 3 band parametric microphone equalizer between “1” and “10”.

15-10 P-EQ1 FREQ

Function: Sets the center frequency of the low range for the 3 band parametric microphone equalizer when the speech processor is activated.

Available Values: OFF/100 - 700

Default: 200

Description: Activates when the speech processor is “ON”. Adjusts the center frequency for the low range of the 3 band parametric microphone equalizer between “100 Hz” and “700 Hz”.

15-11 P-EQ1 LEVEL

Function: Selects the gain setting for the low range of the 3 band parametric microphone equalizer when the speech processor is activated.

Available Values: -20 - 0 - 10

Default: 0

Description: Activates when the speech processor is “ON” and sets the gain for the low range of the 3 band parametric microphone equalizer between “-20 dB” and “+10 dB”.

15-12 P-EQ1 BWTH

Function: Selects the width (“Q”) for the low range of the 3 band parametric microphone equalizer when the speech processor is activated.

Available Values: 1 - 10

Default: 2

Description: Activates when the speech processor is “ON” and sets the width (“Q”) for the low range of the 3 band parametric microphone equalizer between “1” and “10”.

15-13 P-EQ2 FREQ

Function: Selects the center frequency for the middle range of the 3 band parametric microphone equalizer when the speech processor is activated.

Available Values: OFF/700 - 1500

Default: 800

Description: Selects the center frequency for the middle range of the 3 band parametric microphone equalizer between “700 Hz” and “1500 Hz” when the speech processor is activated.

15-14 P-EQ2 LEVEL

Function: Sets the gain for the middle range of the 3 band parametric microphone equalizer when the speech processor is activated.

Available Values: -20 - 0 - 10

Default: 0

Description: Selects the gain setting for the middle range of the 3 band parametric microphone equalizer between “-20 dB” and “+10 dB” when the speech processor is activated.

15-15 P-EQ2 BWTH

Function: Sets the width (“Q”) for the middle range of the 3 band parametric microphone equalizer when the speech processor is activated.

Available Values: 1 - 10

Default: 1

Description: Activates when the speech processor is “ON”, and selects the width (“Q”) setting for the middle range of the 3 band parametric microphone equalizer between “1” and “10”.

15-16 P-EQ3 FREQ

Function: Sets the center frequency for the high range of the 3 band parametric microphone equalizer when the speech processor is activated.

Available Values: OFF/1500 - 3200

Default: 2100

Description: Activates when the speech processor is “ON”, and selects the center frequency setting for the high range of the 3 band parametric microphone equalizer between “1500 Hz” and “3200 Hz”.

15-17 P-EQ3 LEVEL

Function: Sets the gain for the high range of the 3 band parametric microphone equalizer when the speech processor is activated.

Available Values: -20 - 0 - 10

Default: 0

Description: Activates when the speech processor is “ON”, and selects the gain setting for the high range of the 3 band parametric microphone equalizer between “-20 dB” and “+10 dB”.

15-18 P-EQ3 BWTH

Function: Sets the width ("Q") for the high range of the 3 band parametric microphone equalizer when the speech processor is activated.

Available Values: 1 - 10

Default: 1

Description: Activates when the speech processor is "ON", and sets the width ("Q") for the high range of the 3 band parametric microphone equalizer between "1" and "10".

16-01 HF SSB PWR

Function: Sets the transmit RF power output of the SSB on HF band.

Available Values: 5 - 100

Default: 100

16-02 HF AM PWR

Function: Sets the transmit RF power output of the AM on HF band.

Available Values: 5 - 40

Default: 25

16-03 HF PWR

Function: Sets the transmit RF power output of the HF band.

Available Values: 5 - 100

Default: 100

Description: Adjusts the setting of the HF bands transmitter power output.

16-04 50M SSB PWR

Function: Sets the transmit RF power output of the SSB on 50 MHz.

Available Values: 5 - 100

Default: 100

16-05 50M AM PWR

Function: Sets the transmit RF power output of the AM on 50 MHz.

Available Values: 5 - 40

Default: 25

16-06 50M PWR

Function: Sets the transmit RF power output of the 50 MHz band.

Available Values: 5 - 100

Default: 100

Description: Adjusts the setting of the 50 MHz bands transmitter power output.

16-07 SSB MIC GAIN

Function: Sets the microphone gain level for the SSB mode.

Available Values: 0 - 100

Default: 30

16-08 AM MIC GAIN

Function: Sets the microphone gain level for the AM mode.

Available Values: 0 - 100

Default: 30

16-09 FM MIC GAIN

Function: Sets the microphone gain level for the FM mode.

Available Values: 0 - 100

Default: 50

16-10 DATA MIC GAIN

Function: Sets the data input level from the TNC to the AFSK modulator.

Available Values: 0 - 100

Default: 50

16-11 SSB DATA GAIN

Function: Sets the level of the AM signal input when "11-05 [SSB MIC SELECT]" is set to "REAR".

Available Values: 0 - 100

Default: 50

16-12 AM DATA GAIN

Function: Sets the level of the AM signal input when "06-05 [AM MIC SELECT]" is set to "REAR".

Available Values: 0 - 100

Default: 50

16-13 FM DATA GAIN

Function: Sets the level of the AM signal input when "09-01 [FM MIC SELECT]" is set to "REAR".

Available Values: 0 - 100

Default: 50

16-14 DATA DATA GAIN

Function: Sets the level of the AM signal input when "08-09 [DATA IN SELECT]" is set to "REAR".

Available Values: 0 - 100

Default: 50

16-15 TUNER SELECT

Function: Sets the functions of the antenna tuner.

Available Values: OFF/EXTERNAL/ATAS/LAMP

Default: OFF

Description: Selects the antenna tuner to be used or sets the connections for a linear amplifier.

EXTERNAL: Select this item when using the external antenna tuner (the optional FC-50, FC-40, etc.).

ATAS: Select this item when using the Auto active tuning antenna system ATAS-120A.

LAMP: Select this item when connecting the linear amplifier to the TUN/LIN jack on the rear panel.

OFF: Select this item when not using the antenna tuner or the linear amplifier.

16-16 VOX SELECT

Function: Selects the function of the VOX operation.

Available Values: MIC/DATA

Default: MIC

Description: Selects the function of the VOX operation.

MIC: Operates via input from the MIC jack (microphone).

DATA: Operates via input from the RTTY/DATA jack.

16-17 VOX GAIN

Function: Sets the VOX gain.

Available Values: 0 - 100

Default: 50

Description: Sets the operation sensitivity of the VOX circuit. "1" represents the minimum sensitivity and "100" represents the maximum sensitivity. The VOX operation sensitivity may be adjusted while transmitting the signal.

16-18 VOX DELAY

Function: Sets the VOX delay time.

Available Values: 30 - 3000 (msec)

Default: 500msec

Description: While operating VOX, the recovery time (delay time) before returning to receive mode from transmit mode may be set at 10 msec intervals. The delay time may be adjusted while transmitting the signal.

16-19 ANTI VOX GAIN

Function: Sets the VOX anti-trip.

Available Values: 0 - 100

Default: 50

Description: The sensitivity of the anti-trip circuit may be adjusted so that the VOX circuit does not accidentally engage due to the sounds from the transceiver speaker. Increase the anti-trip value to the point that sounds from the transceiver speaker do not engage the transmitter while using VOX operation.

16-20 DATA VOX GAIN

Function: Sets the VOX GAIN while operating VOX during the sending/receiving of data (PSK31, RTTY, etc.).

Available Values: 0 - 100

Default: 50

Description: Set the data input VOX gain to the point that the data signal reliably engages the transmitter, and also releases the transmit when there is no data signal.

16-21 DATA VOX DELAY

Function: Sets the VOX DELAY time while operating VOX during the sending/receiving of data (PSK31, RTTY, etc.).

Available Values: 30 - 3000 (msec)

Default: 100msec

16-22 ANTI DVOX GAIN

Function: Sets the data VOX anti-trip.

Available Values: 0 - 100

Default: 0

Description: The sensitivity of the anti-trip circuit may be adjusted so that the VOX circuit does not accidentally engage due to the received data while operating VOX. Increase the setting to a value that the VOX circuit does not engage due to the received data (the higher the value the greater the operation sensitivity).

16-23 EMERGENCY FREQ

Function: Enables TX/RX operation on the Alaska Emergency Channel, 5167.5kHz.

Available Values: ENABLE/DISABLE

Default: DISABLE

Description: When this Menu Item is set to ENABLE, the spot frequency of 5167.5 kHz will be enabled.

The Alaska Emergency Channel will be found between the PMS memory channel "P9U" and the memory channel "01".

Important: The use of this frequency is restricted to stations operating in or near Alaska, and only for emergency purposes (never for routine operations).

See §97.401(c) of the FCC regulations.

17-01 RESET

Function: Resetting the transceiver settings.

Available Values: ALL/DATA/FUNC

Default: ---

Description: ALL: Use this procedure to restore all settings to their original factory defaults. All Memories will be cleared by this procedure.

DATA: Use this procedure to reset (clear) the previously stored Memory channels, without affecting any configuration changes you may have made to the Menu settings.

FUNC: Use this procedure to restore Menu and Programmable Multi Function [A]/[B]/[C] key settings to their factory defaults, without affecting the programmed memories.

18-01 MAIN VERSION

Function: Displays the Main software version.

18-02 DSP VERSION

Function: Displays the DSP software version.

18-03 LCD VERSION

Function: Displays the LCD software version.

Optional FH-2 Remote Control Switches

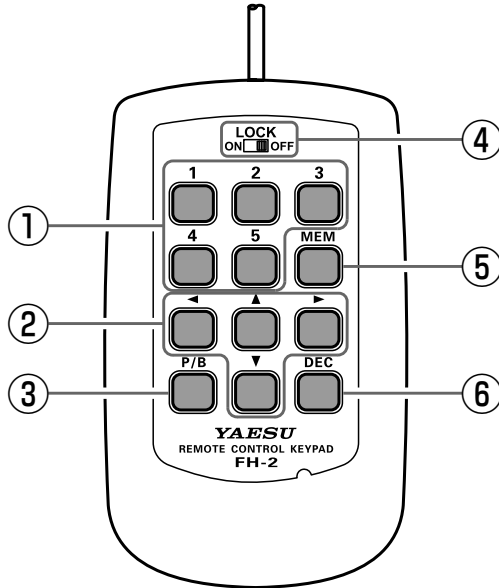

① Voice Memory: 5 Memory Channels for the Memory Keyer

In the case of Voice Memory, up to 20 seconds of audio may be stored on each channel. “MESSAGE Memory” and “TEXT Memory” are available for the Contest Memory Keyer. Each “MESSAGE Memory” channel is capable of retaining a 50-character CW message using the PARIS standard for characters and word length. Each “TEXT Memory” channel is capable of retaining a maximum of 50 characters.

② Cursor Buttons

The cursor may be moved in 2 different directions (right/left). Usually, these buttons are used for tuning the VFO frequency. Press the [▲]/[▼] buttons to change the frequency in the same increments as the microphone [UP]/[DOWN] switches. Press the [◀]/[▶] buttons to change the frequency by 100 kHz steps.

③ [P/B] button

When entering CW text, a space may be inserted where the cursor is flashing.

④ [LOCK] button

The FH-2 key buttons may be locked by setting this switch to “ON”.

⑤ [MEM] button

Press this button to store either a Voice Memory, or a Contest Keyer Memory.

⑥ [DEC] button

When utilizing the sequential contest number capability of the Contest Keyer, press this button to decrement (decrease) the current Contest Number by one digit (i.e. to back up from #198 to #197, etc.).

Optional MH-36E8J Microphone Switches

① **DWN key**

Press the **DWN** (Down) key to scan the frequency downward.

② **UP key**

Press the **UP** key to scan the frequency upward.

③ **DTMF Indicator**

When the DTMF is transmitted, this indicator glows red.

④ **Microphone**

Speak into the microphone in a normal tone of voice with the microphone 5 cm away from your mouth.

⑤ **PTT Switch**

Switches transmit/receive.
Press to transmit and release to receive.

⑥ **DTMF keypad**

Press a key button while holding the PTT switch to transmit a DTMF tone.

⑦ **LOCK Switch**

Slide upward to lock the microphone controls and buttons.

⑧ **LAMP Switch**

Slide upward to illuminate the keypad.

⑨ **A key**

This activates an accessory function. Activates the “FAST” mode when used with the FT-891.

⑩ **B key**

This activates a second accessory function. This button has no function when used with the FT-891.

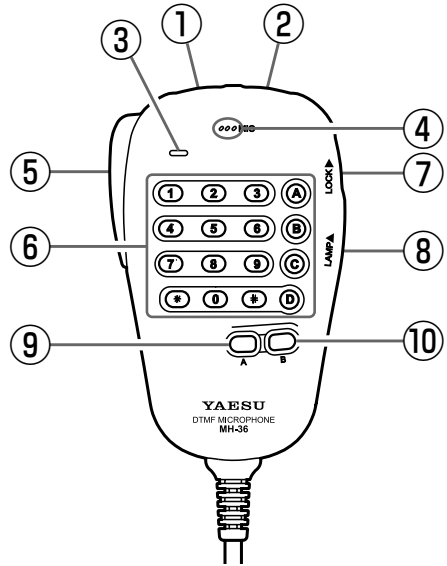

FC-50 External Automatic Antenna Tuner

The optional FC-50 Automatic Antenna Tuner provides automatic tuning of a coaxial line so as to present a nominal 50 Ω impedance to the FT-891's HF/50 MHz antenna port. Please see the FC-50 Installation Manual for detailed information.

Interconnections to FT-891

Connect the cables from the FC-50 to the ANT and TUN/LIN jacks on the rear panel of the FT-891 Transceiver.

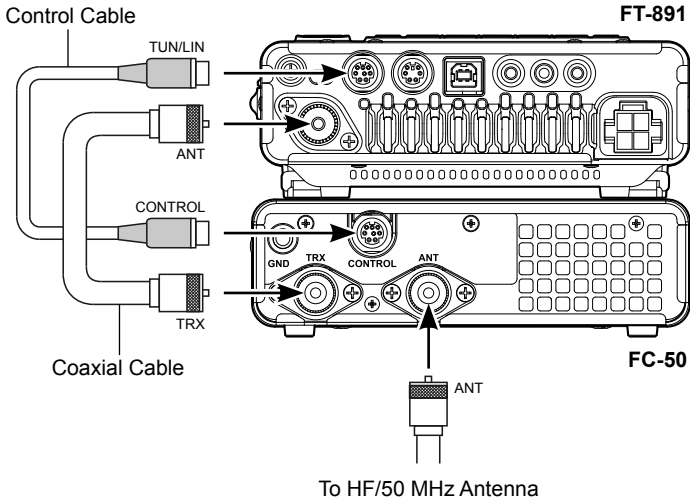

Setup the FT-891

Before operation can begin, the FT-891 microprocessor must be setup to accommodate the FC-50 automatic tuner. This is done using the Menu Mode:

1. Press and hold in the [F] key for one second to activate the Menu mode.
2. Rotate the **MULTI** function knob to select Menu Mode “16-15 [TUNER SELECT]”.
3. Press the **MULTI** function knob, and then rotate it to set this Menu item to “EXTERNAL”.
4. Press the **MULTI** function knob to save the new setting.
5. Press the [F] key to exit the Menu mode and resume normal operation.

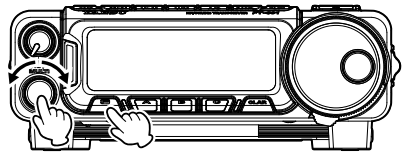

MENU	16-15	TX GNRL
TUNER SELECT		EXTERNAL
VOX SELECT		MIC
VOX GAIN		50
VOX DELAY		500msec

FC-50 External Automatic Antenna Tuner

Operation

1. Press the **[F]** key repeatedly to find the “FUNCTION-1” list screen.
2. Rotate the **MULTI** function knob to select “TNR”.
3. Press and hold the **MULTI** function knob for one second to begin automatic tuning. The transmitter will be engaged, and the “WAIT” will blink while tuning is in progress.
4. Tuning will stop automatically when a low SWR is achieved. You may Press the **MULTI** function knob while tuning is in progress, to cancel the automatic tuning.

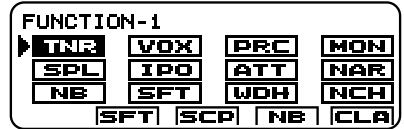
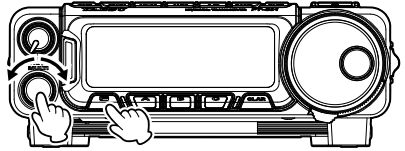

- To set the Antenna Tuner Function to “OFF”:
 1. Press the **[F]** key repeatedly, to find the “FUNCTION-1” list screen.
 2. Rotate the **MULTI** function knob to select “TNR”, and then press the **MULTI** function knob.
 3. Press and hold the **[F]** key for one second to exit the “FUNCTION-1” list screen and resume normal operation.
- Antenna Tuner function may be assigned to the **[A]**, **[B]** or **[C]** key. Refer to “Changing the function assigned to the **[A]**/**[B]**/**[C]** keys” in the FT-891 Operating Manual.
- The carrier signal transmits continuously while tuning is in progress. Please monitor the operating frequency before beginning the tuning process. Be sure you are not interfering with others who may already be using the frequency.
- It is normal to hear the sound of the relays while tuning is in progress.
- If the impedance cannot be matched by the FC-50 better than 1.5:1, and the “Hi-SWR” icon appear, the microprocessor will not retain the tuning data for that frequency, as the FC-50 presumes that you will want to adjust or repair your antenna system to correct the high SWR condition.

FC-40 External Automatic Antenna Tuner (for Wire Antenna)

The FC-40 makes use of the control circuitry built into the transceiver, which allows the operator to control and monitor automatic operation of the FC-40, which mounts near the antenna feed point. The FC-40 uses specially selected, thermally stable components, and is housed in a waterproof case to withstand severe environmental conditions with high reliability.

A carefully-chosen combination of solid-state switching components and high-speed relays allows the FC-40 to match a wide variety of antennas to within a 2:1 SWR on any amateur band frequency (160 through 6 meters), typically in less than eight seconds. Transmitter power required for matching may be as little as 4 - 60 Watts, and matching settings are automatically stored in memory for instant recall when the same frequency range is selected later.

Please see the FC-40 Operating Manual for detailed information.

Interconnections to FT-891

After mounting the FC-40, connect the cables from the FC-40 to the ANT and TUN/LIN jacks on the rear panel of the FT-891 Transceiver.

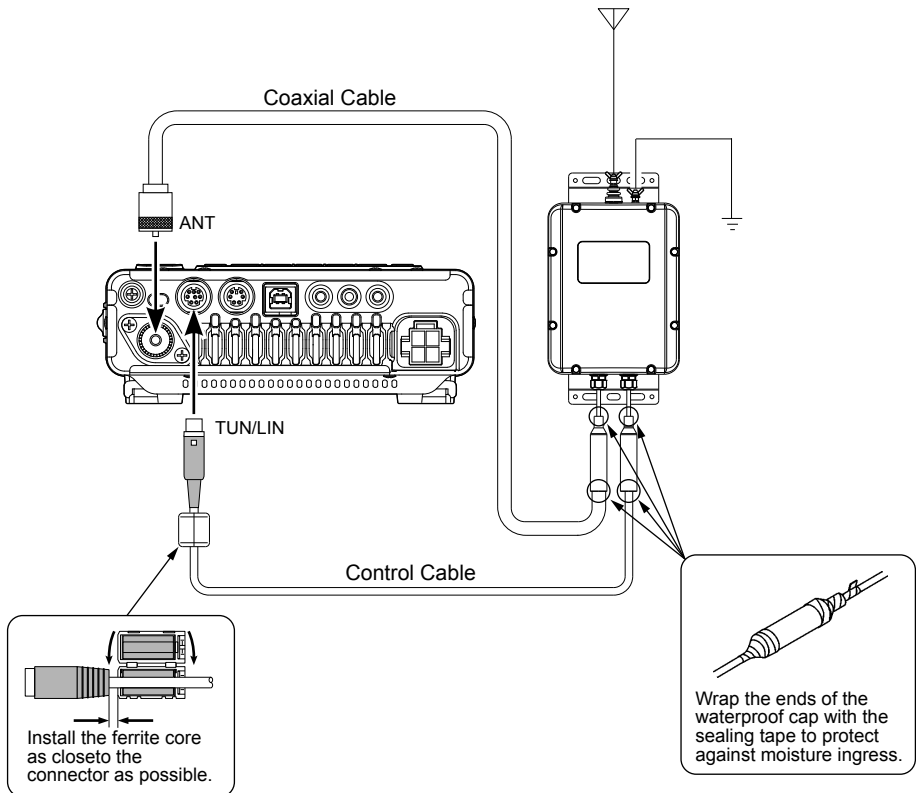

FC-40 External Automatic Antenna Tuner (for Wire Antenna)

Setup the FT-891

Before operation can begin, the FT-891 microprocessor must be setup to accommodate the FC-40 automatic tuner. This is done using the Menu Mode:

1. Press and hold in the [F] key for one second to activate the Menu mode.
2. Rotate the **MULTI** function knob to select Menu Mode “16-15 [TUNER SELECT]”.
3. Press the **MULTI** function knob, and then rotate it to set this Menu item to “EXTERNAL”.
4. Press the **MULTI** function knob to save the new setting.
5. Press the [F] key to exit the Menu mode and resume normal operation.

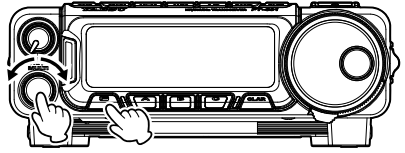

MENU	16-15	TX GNRL
TUNER SELECT	EXTERNAL	
VOX SELECT	MIC	
VOX GAIN	50	
VOX DELAY	500msec	

Operation

1. Press the [F] key repeatedly to find the “FUNCTION-1” list screen.
2. Rotate the **MULTI** function knob to select “TNR”.
3. Press and hold the **MULTI** function knob for one second to begin automatic tuning. The transmitter will be engaged, and the “WAIT” will blink while tuning is in progress.
4. Tuning will stop automatically when a low SWR is achieved. You may Press the **MULTI** function knob while tuning is in progress, to cancel the automatic tuning.

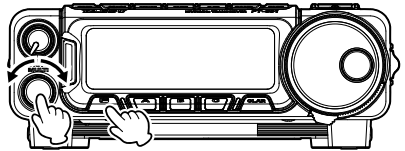

FUNCTION-1			
TNR	VOX	PRC	MON
SPL	IPD	ATT	NAR
NB	SFT	WDH	NCH
SFT SCP NB CLA			

- To set the Antenna Tuner Function to “OFF”:
 1. Press the [F] key repeatedly, to find the “FUNCTION-1” list screen.
 2. Rotate the **MULTI** function knob to select “TNR”, and then press the **MULTI** function knob.
 3. Press and hold the [F] key for one second to exit the “FUNCTION-1” list screen and resume normal operation.
- Antenna Tuner function may be assigned to the [A], [B] or [C] key. Refer to “Changing the function assigned to the [A]/[B]/[C] keys” in the FT-891 Operating Manual.
- The carrier signal transmits continuously while tuning is in progress. Please monitor the operating frequency before beginning the tuning process. Be sure you are not interfering with others who may already be using the frequency.
- It is normal to hear the sound of the relays while tuning is in progress.
- If the impedance cannot be matched by the FC-40 better than 2:1, and the “Hi-SWR” icon appear, the microprocessor will not retain the tuning data for that frequency, as the FC-40 presumes that you will want to adjust or repair your antenna system to correct the high SWR condition.

Auto Active-Tuning Antenna System (ATAS-120A) Operation

ATAS-120A is a multi-band auto-tuning antenna that can be used in the amateur bands from the HF band to the UHF band (7/14/21/28(29) /50/144/430).

Using the active tuning mechanism, tuning can be carried out automatically by the control signal from FT-891. Please refer to the ATAS-120A Operating Manual for the assembly and installation of ATAS-120A.

Interconnections to FT-891

Connect "ATAS-120A" to the ANT terminal of FT-891 with a coaxial cable as shown in the diagram below.

- Turn off the external power supply switch and the FT-891 power supply switch first before connecting the cables.
- Grounding is required for the ATAS-120A. Make sure the antenna base is in contact with the car body to ensure proper grounding.
- Do not plug or unplug the connector of the antenna cable with wet hands. Do not plug or unplug the connector during transmission as well. This may result in electric shock, injury, etc.
- The unit cannot be used with both the antenna tuner and ATAS-120A connected.

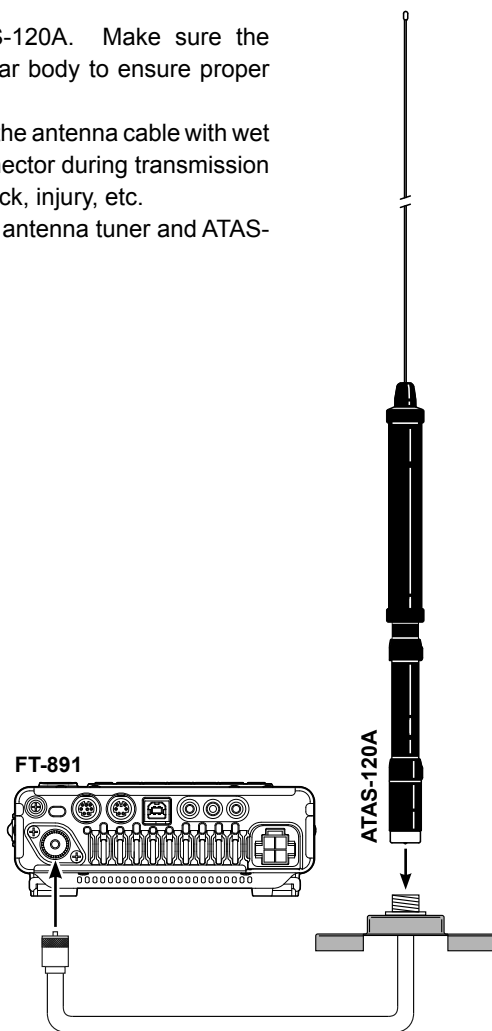

Auto Active-Tuning Antenna System (ATAS-120A) Operation

Setup the FT-891

Before operation can begin, the FT-891 microprocessor must be setup to accommodate the ATAS-120A Auto Active-Tuning Antenna. This is done using the Menu Mode:

1. Press and hold in the [F] key for one second to activate the Menu mode.
2. Rotate the **MULTI** function knob to select Menu Mode "16-15 [TUNER SELECT]".
3. Press the **MULTI** function knob, and then rotate it to set this Menu item to "ATAS".
4. Press the **MULTI** function knob to save the new setting.
5. Press the [F] key to exit the Menu mode and resume normal operation.

The "ATS" icon will appear in the display.

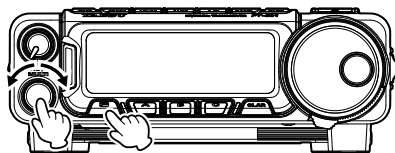

MENU	16-15	TX GNRL
TUNER SELECT	ATAS	
VOX SELECT	MIC	
VOX GAIN	50	
VOX DELAY	500msec	

Tuning Operation

1. Press the [F] key repeatedly to find the "FUNCTION-1" list screen.
2. Rotate the **MULTI** function knob to select "TNR".
3. Press the **MULTI** function knob to begin automatic tuning. The transmitter will be engaged, and the "ATS" icon will blink while tuning is in progress.

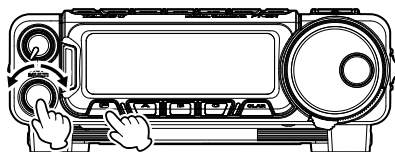

FUNCTION-1			
TNR	VOX	PRC	MON
SPL	IPD	ATT	NAR
NB	SFT	WDH	NCH
SFT	SCP	NB	CLA

4. Tuning will stop automatically when a low SWR is achieved. You may Press the **MULTI** function knob while tuning is in progress, to cancel the automatic tuning.
- Antenna Tuner function may be assigned to the [A], [B] or [C] key. Refer to "Changing the function assigned to the [A]/[B]/[C] keys" in the FT-891 Operating Manual.
 - Check the grounding and installation conditions if "Hi-SWR" icon appear (tuning cannot be carried out).
 - As transmit signals are emitted during tuning, take note not to interfere with any communication that is already in progress on the frequency.

Auto Active-Tuning Antenna System (ATAS-120A) Operation

Manual Tuning

Carry out the tuning of the ATAS-120A manually.

Manual tuning with the MH-31A8J

1. Press and hold the PTT switch on the microphone to transmit.
2. Press (press and hold) the [UP] or [DWN] key on the microphone to adjust the antenna until the meter indicates the minimum SWR.

Manual tuning from the FT-891 Control Panel

1. Press the [F] key repeatedly to find the “ATAS SETTING” list screen.

NOTE: This screen may be enabled/disabled via Menu Mode “05-12 [ATAS SETTING]”.

2. Press and hold the PTT switch on the microphone to transmit.
3. Rotate the **MULTI** function knob to select [▲] or [▼], and then press (press and hold) the **MULTI** function knob to adjust the antenna until the meter indicates the minimum SWR.

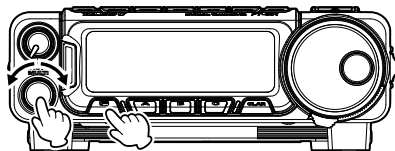

VL-1000 Linear Amplifier Interconnections

Be sure that both the FT-891 and VL-1000 are turned off, and then follow the installation recommendations contained in the illustration.

- Refer to the VL-1000 Operating Manual for details regarding amplifier operation.
- Do not attempt to connect or disconnect coaxial cables when your hands are wet.
- Set the Menu item "16-15 [TUNER SELECT]" to "LAMP".
- Since the ALC cable is connected to the REM/ALC jack, the optional FH-2 cannot be connected.

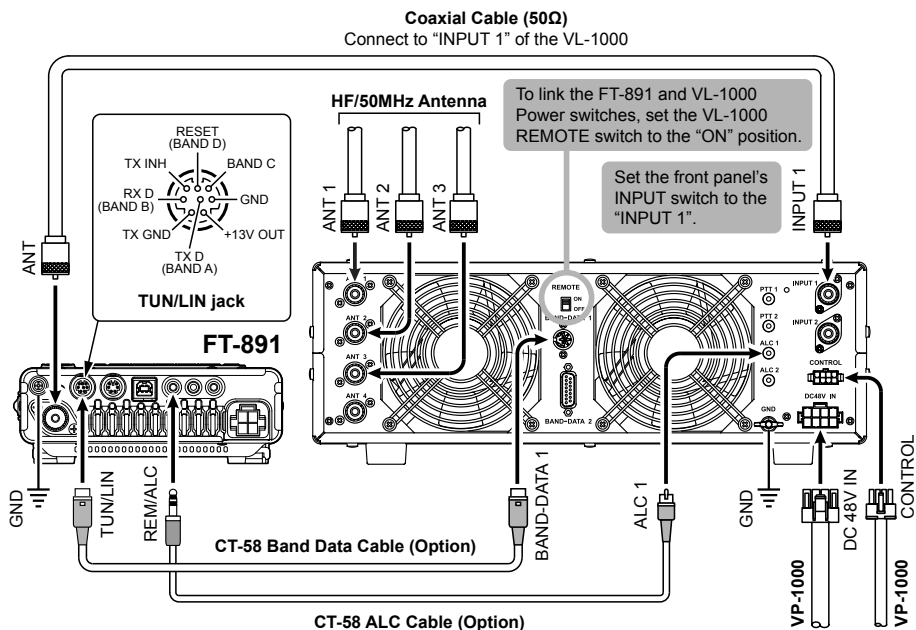

Index

A

AGC.....	36
Alaska Emergency Frequency.....	55
APO.....	59
ATAS-120A.....	108
ATT.....	35
Attenuator.....	35
Audio Filter.....	37
Audio Peak Filter.....	10
Automatic Gain Control.....	36
Automatic Power Off.....	59

B

Beep Level.....	58
-----------------	----

C

Contest Memory Keyer.....	11
Message Memory.....	11
Text Memory.....	17
Text Memory Storage.....	17
Transmitting in the Beacon Mode.....	24
Contest Number Programming.....	23
Decrementing the Contest Number.....	23
CONTOUR Control Operation.....	29
CW Delay Time Setting.....	8
CW Mode Operation.....	3
Setup for Straight Key.....	3
Using the Built-in Electronic Keyer.....	4
CW Pitch Adjustment.....	8
CW Spotting.....	9

D

DATA Operation.....	64
DATA (PSK) Operation.....	64
DCS Operation.....	28
Digital Noise Reduction.....	33
Digital NOTCH Filter.....	34
DNF.....	34
DNR.....	33

E

Enhancing Transmit Signal Quality.....	38
--	----

F

FAN Control.....	59
FC-40.....	106
FC-50.....	104
FH-2.....	102
FM Mode Operation.....	25
Full Break-in.....	5

I

IF NOTCH.....	32
Intercept Point Optimization.....	36
Interference Rejection.....	29
IPO.....	36

K

Keyer Operating Mode.....	7
keyer speed.....	5
Keyer Weight (Dot/Dash) Ratio.....	6
Key Lamp Dimmer.....	61

L

Labeling Memories.....	52
------------------------	----

M

Memory Groups.....	53
Choosing the Desired Memory Group.....	54
Memory Group Assignment.....	53
Memory Operation.....	51
Memory Tune.....	51
Menu Mode.....	69
Meter Peak Hold.....	60
MH-36E8J.....	103
Mic Gain.....	38
Miscellaneous Setting.....	58
MONITOR.....	47
MT.....	51

N

NARROW (NAR).....	31
-------------------	----

P

Parametric Microphone Equalizer.....	39
PMS.....	57
POP-UP Menu.....	60
Programmable Memory Scanning.....	57
PSK.....	64

Index

R

Radio Teletype	62
Receiver Audio Filter	37
Repeater Operation	26
Reversing the Keyer Polarity	6
RF Gain	35
RTTY Operation	62
RTTY (Radio Teletype) Operation	62

S

Scanning Operation	56
Scan Resume Options	56
Speech Processor	38
Split-Frequency Operation	49
Quick Split Operation	50
Split Operation	48
SSB Transmitted Bandwidth	41

T

Time-Out Timer	58
Tone Squelch Operation	27
Tools for Comfortable and Effective Reception	35
TOT	58
Transmitter Convenience Features	42
TX/BUSY Indicator Dimmer	61

V

VL-1000	111
Voice Memory	42
VOX	46

W

WIDTH (IF DSP Bandwidth) Tuning	30
---------------------------------------	----

Z

Zero-Beating	9
--------------------	---

YAESU

The radio

Copyright 2016
YAESU MUSEN CO., LTD.
All rights reserved.
No portion of this manual may be
reproduced without the permission of
YAESU MUSEN CO., LTD.

1612-E